

NASA/TM—2013–216608

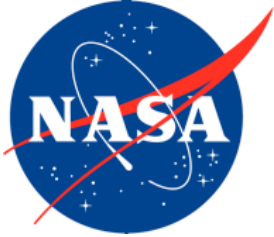

Jet Single-Pilot Simulation Study Scenario Overviews, Task Analyses, and Concurrent Task Timelines

Barbara K. Burian
NASA Ames Research Center

Bonny Christopher
San Jose State University Foundation

Dave Fry
San Jose State University Foundation

Shawn Pruchnicki
San Jose State University Foundation

Evan Silverman
San Jose State University

October 2013

NASA STI Program...in Profile

Since it's founding, NASA has been dedicated to the advancement of aeronautics and space science. The NASA scientific and technical information (STI) program plays a key part in helping NASA maintain this important role.

The NASA STI program operates under the auspices of the Agency Chief Information Officer. It collects, organizes, provides for archiving, and disseminates NASA's STI. The NASA STI program provides access to the NASA Aeronautics and Space Database and its public interface, the NASA Technical Report Server, thus providing one of the largest collections of aeronautical and space science STI in the world. Results are published in both non-NASA channels and by NASA in the NASA STI Report Series, which includes the following report types:

- **TECHNICAL PUBLICATION.** Reports of completed research or a major significant phase of research that present the results of NASA Programs and include extensive data or theoretical analysis. Includes compilations of significant scientific and technical data and information deemed to be of continuing reference value. NASA counterpart of peer-reviewed formal professional papers but has less stringent limitations on manuscript length and extent of graphic presentations.
- **TECHNICAL MEMORANDUM.** Scientific and technical findings that are preliminary or of specialized interest, e.g., quick release reports, working papers, and bibliographies that contain minimal annotation. Does not contain extensive analysis.
- **CONTRACTOR REPORT.** Scientific and technical findings by NASA-sponsored contractors and grantees.
- **CONFERENCE PUBLICATION.** Collected papers from scientific and technical conferences, symposia, seminars, or other meetings sponsored or co-sponsored by NASA.
- **SPECIAL PUBLICATION.** Scientific, technical, or historical information from NASA programs, projects, and missions, often concerned with subjects having substantial public interest.
- **TECHNICAL TRANSLATION.** English-language translations of foreign scientific and technical material pertinent to NASA's mission.

Specialized services also include creating custom thesauri, building customized databases, and organizing and publishing research results.

For more information about the NASA STI program, see the following:

- Access the NASA STI program home page at <http://www.sti.nasa.gov>
- E-mail your question via the Internet to help@sti.nasa.gov
- Fax your question to the NASA STI Help Desk at (301) 621-0134
- Phone the NASA STI Help Desk at (301) 621-0390
- Write to:
NASA STI Help Desk
NASA Center for AeroSpace Information
7121 Standard Drive
Hanover, MD 21076-1320

NASA/TM—2013–216608

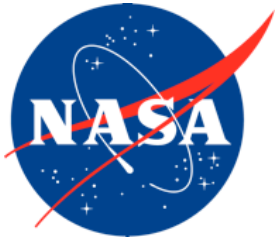

Jet Single-Pilot Simulation Study Scenario Overviews, Task Analyses, and Concurrent Task Timelines

Barbara K. Burian
NASA Ames Research Center

Bonny Christopher
San Jose State University Foundation

Dave Fry
San Jose State University Foundation

Shawn Pruchnicki
San Jose State University Foundation

Evan Silverman
San Jose State University

*National Aeronautics and Space Administration
Ames Research Center, Moffett Field, California*

October 2013

Acknowledgments

This work was sponsored by FAA AFS-800, Flight Standards Service – General Aviation and Commercial Division, and funded through FAA ANG-C1, Human Factors Research and Engineering Division, Study: 09-AJP61FGI-0048. Captain Randy Phillips (ret.) and Lynne Martin contributed greatly to early work on the study and scenario design and framework for the tasks analyses, which were supported by the Integrated Intelligent Flight Deck Project of NASA’s Aviation Safety Program.

As part of this study, we relied on the expertise and experience of three air traffic control subject matter experts: Robert Browne, Art Gilman, and Greg Elwood. Their expertise contributed greatly to the success of this project. We would also like to extend our thanks to our research collaborators at the FAA’s Aerospace Human Factors Research Lab at the Civil Aerospace Medical Institute (CAMI) with whom we conducted the human-in-the-loop simulation study referenced in this report: Carla Hackworth, Jason Rogers, Kevin Williams, Gena Drechsler, Kali Holcomb, Jerry Ball, Kevin Gildea, Barry Runnels, and Andy Mead.

The use of trademarks or names of manufacturers in this report is for accurate reporting and does not constitute an official endorsement, either expressed or implied, of such products or manufacturers by the National Aeronautics and Space Administration

Available from:

NASA Center for Aerospace Information
7121 Standard Drive
Hanover, MD 21076-1320
(301) 621-0390

This report is also available in electronic form at <http://www.sti.nasa.gov>
or <http://ntrs.nasa.gov/>

Table of Contents

<i>Acronyms and Definitions</i>	<i>vi</i>
1. Introduction.....	1
2. Scenario High Level Overviews	3
2.1 High Level Overview of Experimental Flight Leg 1, KTEB–KMTN.....	3
2.2 High Level Overview of Experimental Flight Leg 2, KMTN–KHSP.....	10
3. Analyses of Discrete Scenario Tasks.....	16
4. Concurrent Task Timelines.....	16
4.1 Concurrent Task Timeline for Experimental Flight Leg 1, KTEB–KMTN	17
4.2 Concurrent Task Timeline for Experimental Flight Leg 2, KMTN–KHSP	17
5. References.....	17
Appendix A-1. Scenario for Flight Leg 1	18-59
Appendix A-2. Scenario for Flight Leg 2.....	60-102
Appendix B-1. Timeline for Flight Leg 1.....	103-129
Appendix B-2. Timeline for Flight Leg 2.....	130-158

Acronyms and Definitions

AOS	Automated Surface Observation System
ATC	air traffic control
ATIS	Automated Terminal Information Service
ATOS	automatic terminal information service
AWOS	Automated Weather Observing System
CAMI	Civil Aerospace Medical Institute
DME	distance measuring equipment
ET	elapsed time
FAA	Federal Aviation Administration
FBO	fixed base operator
FL	flight level
FMS	flight management system
GPS	global positioning system
GPU	ground power unit
HITL	human-in-the-loop
IFR	instrument flight rules
ILS	instrument landing system
IMC	instrument meteorological conditions
KHSP	Ingalls Field, Hot Springs (Virginia)
KMTN	Martin State Airport, near Baltimore, Maryland
KTEB	Teterboro Airport, New Jersey
LOFT	line-oriented flight training
MDA	minimum descent altitude
METAR	meteorological aerodrome report
MFD	multi function display
MSL	mean sea level
NASA	National Aeronautics and Space Administration
nm	nautical miles
PFD	primary flight display
RAIM	receiver autonomous integrity monitoring
RNAV	area navigation
RWY	runway
SME	subject matter expert
SOP	standard operating procedure
TAF	terminal area forecast
TOD	top of descent
VNAV	vertical navigation
VOR	very high frequency omni directional radio range

Jet Single-Pilot Simulation Study Scenario Overviews, Task Analyses, and Concurrent Task Timelines

Barbara K. Burian¹, Bonny Christopher², Dave Fry²,
Shawn Pruchnicki², and Evan Silverman²

Abstract

In a recently completed human-in-the-loop simulation study, the workload management strategies, techniques, and automation use of single-pilots flying an entry-level jet flight training device (i.e., ‘simulator’) were examined (Burian, et al., 2013). Prior to data collection, we completed an analysis of the tasks to be performed by participants as prescribed by the flight scenarios we developed. Since many tasks could be completed in different ways and the timing of various actions during the flights could vary from one pilot to the next, we completed our task analysis based on the approach to the flights and tasks taken by a mentor pilot subject matter expert (SME) who is type-rated in our study aircraft—a Cessna Citation Mustang. Also with the help of the pilot SME, we developed timelines that depicted how tasks identified through the task analyses would be completed concurrently over the course of a flight according to how the SME would have flown the scenarios. The task analyses and concurrent task timelines we developed are included in this report as well as the high level overviews of the experimental scenarios upon which they are based.

1. Introduction

We recently completed an exploratory, human-in-the-loop (HITL) simulation study in collaboration with researchers in the FAA’s Aerospace Human Factors Research Lab at the Civil Aerospace Medical Institute (CAMI). In this study we examined the workload management and automation use strategies of pilots flying entry-level jets (Burian, et al., 2013). With the help of an airline pilot and instructor, a Cessna Citation Mustang Mentor Pilot, and air traffic control (ATC) experts, we developed an experimental flight scenario—comprised of two legs—for our participants to fly. Each leg was intended to resemble typical flights that might be flown by single pilots in the busy airspace of the northeastern United States corridor.

We began the scenario development process by identifying specific high workload tasks that we wanted to present to our pilots. Some tasks were suggested to us by study sponsors because they were tasks that many pilots had difficulty completing without error in the real world, such as the TEB6 standard instrument departure out of Teterboro, New Jersey. Other tasks, such as intercepting a radial, were chosen because there are a variety of automation solutions for completing them in the aircraft type used in this study. In all cases, we wanted to include tasks that might be encountered on a typical

¹ NASA Ames Research Center; Moffett Field, California.

² San Jose State University Foundation; San Jose, California.

flight and presented participants several opportunities to manage high workload with many concurrent tasks and use the advanced technologies and automation aboard the aircraft. Detailed information about the final set of scenarios used in the study can be found in Burian et al. (2013) and Burian, Pruchnicki, & Fry (2013).

The scenario development process was an iterative one involving the identification of possible airports, routing, and tasks and comparing these with the capabilities of the Cessna Citation Mustang level 5 flight training device ('simulator') to be used for data collection. Once we settled on these features for each leg of the experimental flight, we constructed high-level descriptions or 'overviews' of the flights, including instructions from ATC to the pilots during each leg. The contributions of one of our subject matter experts (SMEs) who was an airline instructor and retired airline pilot with experience in developing line-oriented flight training (LOFT) scenarios for airline pilot training, was invaluable to this process.

During the scenario design phase we also consulted ATC SMEs to ensure that the routing and tasks were acceptable from an air traffic management perspective. Although some of the flight paths we chose were unusual and not typically assigned in the real world by ATC (e.g., staying at 2,000ft MSL for quite a long time after departing Martin State Airport in Baltimore, Maryland), our ATC SMEs told us that they were still possible and thus acceptable. They were designed this way in an effort to balance realism with the task needs of our study. All of our choices during scenario design, including the somewhat atypical flight paths, were driven by the various workload management tasks we wanted to present to our participants.

Following the completion of the high level overviews of the scenarios, our Cessna Citation Mustang SME helped us break them down into discrete sets of tasks and subtasks. Pilot workload management and automation use while airborne were of primary interest in this study. Therefore, although our participants flew the two experimental legs from aircraft pre-flight through engine shut down, we only completed the task analyses starting with the pilots' taking the active runway prior to take-off at their departure airport through taxiing off the runway after landing at their destination airport. The task analyses and the concurrent task timelines we developed, described below, were used during data analysis to compare the methods participants took in completing tasks and managing their workload with those suggested by our SME who is an instructor and mentor pilot in the aircraft.

By its nature, the analysis of tasks and identification of the subtasks which comprise them, involves generating a sequential list of actions to be completed. We did this using Microsoft Excel™. However, when presented as such a list, it can appear that a task and its associated subtasks are completed as a set, in their entirety, before the next task is begun. In reality, however, particularly in an aircraft cockpit, it is more common for many tasks to be completed concurrently or interleaved with each other (Dismukes, 2010; Loukopoulos, Dismukes, & Barshi, 2009). Furthermore, in such a listing it is difficult to capture some tasks which must continually be completed 'in the background' to the performance of other discrete tasks such as monitoring the cockpit instruments.

Therefore, after we completed the task analyses of both legs of the experimental flight, our Citation Mustang SME also helped us construct a set of concurrent task timelines in Microsoft PowerPoint™ using the tasks and subtasks identified in the task analyses. These timelines also included continual tasks that needed to be completed by the participants that were not specifically identified through the analysis of discrete tasks (e.g., instrument scan). With time represented on the horizontal axis, we were able to show the relationship of when tasks would be completed relative to each other, as our SME

would have flown the scenarios. On these concurrent task timelines, the tasks and subtasks are grouped in four different categories: 1) tasks involving the use of the Garmin G1000 avionics suite aboard the aircraft; 2) tasks involving communication with ATC, other pilots, and setting up and using the radios; 3) monitoring tasks, including on-going monitoring such as a scan of cockpit instruments; and 4) manual flying tasks. All subtasks are coded the same color as the higher-level task of which they are a part to make it easier to identify tasks and subtasks that go together when they are split up across the four different categories on the page. The timelines were used to confirm segments of the flights likely to contain high workload which in turn focused subsequent analysis of data collected during the simulation study.

Section 2 of this document contains the high level scenario overviews; Section 3 describes the analyses of the discrete scenario tasks; and Section 4 provides a brief overview describing certain features and conventions used in the construction of the concurrent task timelines. The actual task analysis of the experimental flights are contained in Appendix A (pages 18–100) and the concurrent task timelines are presented in Appendix B (pages 101–154).

2. High Level Scenario Overviews

In the high level overviews of the scenarios developed for the two legs of flight below, communication from ATC, Flight Watch weather briefers, and automated reporting systems such as Automatic Terminal Information Service (ATIS) or Automated Surface Observation System (ASOS) recordings appear in *italicized blue* type. Radio communication from other ‘pilots,’ played by the experimenters during data collection, are depicted in *italicized red or green* type. The participant aircraft is noted as “Citation XXXX” in the communications from ATC, however a tail number of each participant’s choosing was used in its place during data collection in the simulator (e.g., “Citation 123AA”). Events during the scenario that triggered a certain ATC call to the aircraft, such as the aircraft arriving at a particular waypoint, is noted in **bold green** type. These same color coding conventions also are used in the task analyses which follow these high level overviews.

2.1 High Level Overview of Experimental Flight, Leg 1, KTEB-KMTN

2.1.1. Background

This is the first leg of a two leg flight which begins at Teterboro, New Jersey (KTEB) and ends Martin State Airport near Baltimore, Maryland (KMTN) during daylight hours in September on a moderate instrument flight rules (IFR) day. The single pilot operator is the sole occupant and an IFR flight plan is filed. The aircraft is a Cessna 510 Citation Mustang equipped with a Garmin G1000 avionics suite and autoflight system. Following the cockpit setup and G1000 initialization, the flight is cleared to Martin State Airport via the Teterboro Six Departure. Runway two-four is in use for departure and the initial assigned altitude is 2,000ft MSL. During the departure, rain and a slight crosswind are present.

As the scenario begins, the aircraft is fully fueled and is parked at Signature Aviation, a fixed base operator (FBO) at KTEB. The departure procedure is complex as is the airspace surrounding New York City. Instrument meteorological conditions (IMC) is encountered during the initial climb and once established en route with New York Center radar vectors and route modifications are assigned. Altitude restrictions are also applied to avoid traffic conflicts. The flight evolves normally and is representative of a typical flight in the U.S. northeastern corridor. After handoff to Washington Center, and following a brief hold, the single pilot completes the RNAV (GPS) RWY33 non-precision approach in moderate IMC conditions (i.e., ceilings were a few hundred feet above instrument

approach minimums). After breaking out into visual conditions the pilot circles to land on Runway 15. Following the landing, the aircraft proceeds to the FBO and parks on the ramp so the pilot can ‘pick up a parcel.’ The second leg of the flight will be flown soon thereafter.

Principal G1000 Elements

- G1000 preflight initialization
- Flight plan entry
- Aircraft fuel and loading entries
- Communication and navigation radio tuning
- Taxi route identification and monitoring
- Database procedure selections
- Vertical and lateral navigation auto-flight manipulation
- ‘Direct to’ and ‘intercept course to’ FMS tasks
- Route modifications
- Meeting crossing restriction at a waypoint
- Assessing fuel remaining at destination
- Holding pattern execution
- RNAV (GPS) non-precision approach execution

2.1.2. Aircraft Fuel and Weight

The airplane has a basic empty weight of 5,344 pounds and is fueled with its maximum of 2,580 pounds of fuel. The weight of the single pilot and baggage is 250 pounds. Eighty five pounds of fuel will be burned during taxi, yielding a takeoff weight of 8,155 pounds.

2.1.3. Flight Plan

An IFR flight plan is filed via J75 to KMTN at a true airspeed of 330 knots for an estimated time en route of 43 minutes at a requested altitude of FL200.

2.1.4. Phase of Flight Events

- **Preflight Preparation at Aircraft** (*Approximate Elapsed Time (ET) 00:00*)
 1. Battery – CONNECT - deferred
 2. Pitot Covers – REMOVE - deferred
 3. Cockpit Preparation (cockpit set-up flow)– COMPLETE
 4. Cockpit Set-up Checklist - COMPLETE
 5. Lights – ON - deferred
 6. Pitot Heat – ON 20 SECONDS, THEN OFF - deferred
 7. Lights and Hot Items – CHECK - deferred
 8. Lights – OFF - deferred
 9. External Preflight – PERFORM - deferred
 10. GPU – CONNECT
 11. Battery – ON
 12. Avionics Power – ON
 13. G1000 Initialization
 14. PFD Alert Messages – CHECK AND RESOLVE (G1000)
 15. Fuel, Weight, and Performance Entries – COMPLETE
 16. Takeoff Data – SET and ON

17. Copy ATIS – 132.85:

Teterboro Information ALPHA 1253 Zulu automated weather, wind is 220° at 9 gusting to 15, visibility 2 miles in light rain, 500 broken, 800 overcast, temperature 20, dew point 17, altimeter 29.85. ILS Runway 24 approach in use. Landing and departing Runway 24. Notice to airmen: Read back all runway assignments and all hold short instructions. Migratory birds are on & near the airport. Advise the controller upon initial contact you have information ALPHA.

18. Request and copy ATC clearance – 128.05:

• *“Citation XXXX is cleared to the Martin State Airport via the Teterboro Six Departure, radar vectors BIGGY, J75, MURPH, Baltimore direct. Maintain 1500 until passing the TEB 4.5DME then climb and maintain 2000. Expect FL200 10 minutes after departure. New York departure on 126.7, Squawk 3405.”*

19. Select departure procedure from database (G1000)

20. Enter assigned route on MFD FPL page (G1000)

21. Select anticipated approach procedure from database (G1000)

22. Set communication frequencies (G1000)

23. Tune navigation radios and set courses (G1000)

24. Set initial heading and altitude (G1000)

25. Set transponder code (G1000)

26. Review departure procedure

27. Review en route chart

28. Review destination airport charts [This isn't an approach brief, it's just a check to ensure they are all available.]

29. Complete Preflight Checklist

• **Engine Start** (*ET 00:15*)

30. Complete Before Start Checklist

31. Monitor engine parameters per Cessna SOP (G1000)

32. Complete After Start SOP

33. PFD Alert messages - check and resolve (G1000)

• **Taxi Out** (*ET 00:18*)

34. Configure aircraft per Cessna SOP

35. Confirm avionics set up – SAFE TAXI (G1000)

36. Confirm take off data (G1000)

37. CAS messages – check & resolve (G1000)

38. Complete Before Taxi Checklist

39. Request ATC taxi clearance – 121.9

• *“Citation XXXX taxi Papa-Lima-hold short of Runway 19. Expect Runway 24 intersection departure at Runway 19. Monitor tower holding short of 19.”*

40. Confirm taxi routing on MFD (G1000)

41. Accomplish brake and flight control check

42. Taxi out

43. Complete Before Takeoff Checklist down to the line

44. Switch to tower frequency

- “4 Charlie Tango climb and maintain 1500, looks like your main gear is down but I did not see your nose gear—state your intentions.”
 - *Uh..standby*
- “Pilatus 7AF, contact departure, good day.”
 - *Departure for 7 Alpha Foxtrot, goodbye.*
- ****Continuing multiple comms with different aircraft****

45. Review Takeoff Checklist

46. Select desired climb mode (FD, HDG & ALT armed G1000)

47. Engage flight guidance and navigation modes as necessary (G1000)

• **Takeoff (ET 00:30)**

48. Obtain ATC takeoff clearance – 119.5

- *“Citation XXXX taxi on Runway 19 and line up and wait Runway 24. Be ready to go.”*

49. Finish the Before Takeoff Checklist

50. All Lights – ON

51. Windshield Heat – ON

52. Pitot Heat - ON

53. Taxi onto Runway 24 line-up and wait in position

*****Begin Task Analysis*****

54. **(Aircraft is in position and Holding RWY 24)** Receive takeoff clearance and take off

- *“Citation XXXX, Winds 220 at 9, Runway 24 intersection departure, cleared for takeoff.”*

55. Rotation at V_R

• **Climb (ET 00:31)**

56. Retract gear and flaps per Cessna SOP, begin flying departure

- *Enter clouds at 800 ft*

57. Engage auto-flight as necessary (G1000)

58. Perform takeoff flow check

59. **(As aircraft reaches 1300ft MSL)** Change frequency and check in with Departure controller

- *“Citation XXXX contact departure 126.7”*
- *“Citation XXXX, New York Departure, radar contact XXXX ft.” (alt)*

60. Level off at 1500ft

61. Monitor first departure turn

62. Initiate climb

63. Complete after takeoff/climb checklist

64. Level off at 2,000ft

65. **(Aircraft is 10 DME from TEB)** Respond to ATC traffic call

- *“Citation XXXX, you have crossing traffic, 2 o'clock and ten miles at 4000, an United 737 going to LaGuardia”*

66. **(Aircraft is 15 DME from TEB)** Respond to ATC call with clearance

- *“Citation XXXX, fly heading 270 to intercept the Broadway 208 radial to BIGGY as filed.”*
- *“Citation XXXX, readback correct. Climb and maintain 6000 feet. Contact New York Departure 132.80”*
- *“Citation XXXX, roger.”*

67. Build course to intercept BWZ 208 radial and then to BIGGY
68. Level off at 6,000ft
69. **(Aircraft is 30 DME from TEB, clear of traffic)** Respond to revised clearance from ATC
 - *“Citation XXXX, clear of traffic, proceed direct to BIGGY then as filed. Climb and maintain FL200. Contact New York Center on 135.45”*
 - *“Citation XXXX maintain FL200, report reaching.”*
70. Complete FL180 transition level check
71. Monitor climb to FL200
72. Monitor reaching first waypoint on route

• **Cruise** *(ET 00:50)*.

73. Report reaching FL200 to ATC
 - *“Citation XXXX thank you”*
74. Complete cruise flow
75. Complete cruise checklist
76. Retrieve METAR and TAF via XM data-link (G1000)
- 76 (Alternate). Get METAR from flight watch (XM data-link unavailable)
 - *“Citation XXXX cleared off frequency report back on”*
 - *“Citation XXXX, Flight Watch, say time of arrival at Martin State”*
 - *“Citation XXXX stand-by”*

“Citation XXXX, current weather at Martin State is wind 120 at 13, visibility 3 miles with mist, 800 scattered, 1000 overcast, temperature 18, dew point 16, altimeter 29.89. No PIREPS. Forecast for Martin State from 1200 Zulu until 1600 Zulu, wind 120 at 5, visibility 5 miles, 1500 foot overcast. No precipitation. Conditions to improve slightly later this afternoon. Is there anything else you need? “

- *“Citation XXXX, do you have time to give me a PIREP”*
 - *“Citation XXXX, thank you very much”*
 - *“Citation XXXX roger”*
77. **(When aircraft reaches COPES intersection)** Get and respond to ATC call with re-route
 - *“Citation XXXX, I have an amendment to your routing. Advise when ready to copy.”*
 - *“Citation XXXX is now cleared to Martin State Airport via J75, Modena (MXE), direct Dupont (DQO), Victor 214 to KERNO, direct to JUGMO direct Martin State.*
 - *“Citation XXXX read back correct, cross Dupont at or below 17,000. Maintain 12,000. Philadelphia altimeter is 29.89.*
 78. Input re-route into flight plan
 79. Build VNAV path to identify descent point
 80. Monitor TOD and initiation of descent on VNAV path

• **Descent** *(ET 01:00)*

81. Report leaving FL200
 - *“Citation XXXX - roger.”*
82. Do descent flow
83. Complete Descent Checklist
84. Complete FL180 transition check
85. Listen to ATIS for KMTN – 124.925

Martin State Airport Information HOTEL 1253 Zulu automated weather, wind 120 at 13, visibility 3 miles in mist, 800 scattered, 1100 overcast, temperature 19, dew point 17, altimeter 29.90. RNAV approaches are in use, landing and departing Runway 15. Notice to airmen: the ILS for Runway 33 is out of service. Read back all runway assignments and all hold short instructions. Birds are on and near the airport. Advise the controller upon initial contact you have information HOTEL.

86. Prepare for arrival and RNAV (GPS) approach to Runway 33 at KTEB, Select and load into G1000
87. Brief approach
88. RAIM prediction
89. **(As aircraft turns over MODENA VOR)** Contact new center controller as directed by ATC
 - *“Citation XXXX, contact Washington Center now 134.50”*
90. **(A/C at 17500ft MSL)** Descend to 8000ft
 - *“Citation XXXX, cross Dupont at or below 17,000, descend and maintain 8000. Wilmington Altimeter 29.85”*
91. **(A/C at 15000ft MSL)** Set up frequencies for approach and landing
 - *“Citation XXXX, contact Potomac approach on 119.0”*
92. Contact approach controller
 - *“Citation XXXX, descend and maintain 3000, (thanks for Hotel). Expect the Martin State RNAV Runway 33 approach circle to land Runway 15 (“Advise when you have Martin State information Hotel” if pilot doesn't say that he has Hotel when checking in)”*
93. Adjust aircraft external lights
 - *“King Air 79 Romeo you have opposite direction converging traffic at 1 o'clock, 25 miles, a Citation Mustang descending to 3000. They will be following you into Martin State.”*
94. **(Aircraft reaches ODESA)** Respond to ATC traffic advisory
 - *“Citation XXXX, you have opposite direction converging traffic at 11 o'clock and 25 miles, a King Air descending to 2000. You will be following him into Martin State.”*
95. Prepare for level off at 3,000ft
96. **(Aircraft reaches KERNO)** ATC gives holding clearance to King Air
 - *“King Air 79R, you can expect a short delay into Martin State. Advise when ready to copy holding clearance.”*
 - *“King air 79R is cleared to hold southeast of JUGMO, on the 326 degree bearing inbound, left hand turns, maintain 2000, expect approach clearance in 20 minutes.”*
 - *“King air 79R, read back correct”*
97. Respond to ATC call about having to perform a hold
 - *“Citation XXXX, you also can expect a short delay into Martin State. Advise when ready to copy holding clearance.”*
 - *“Citation XXXX is cleared to hold southeast of JUGMO, on the 326 degree bearing inbound, left hand turns, maintain 3000, expect approach clearance in 20 minute.”*
 - *“Citation XXXX, read back correct.*
98. Prepare and fly hold
 - *“King Air 79R, roger.” (In response to pilot reporting entering the hold)*
 - *“Citation XXXX, roger.”(In response to pilot reporting entering the hold)*
99. King Air is cleared for the approach
 - *“King Air 79 Romeo maintain 2000 until established. Cleared for the Runway 33 RNAV approach to Martin State circle Runway 15.”*

- *“King Air 79 Romeo, readback is correct, Contact Martin State tower on 121.3 crossing CINDI.”*

100. Complete approach checklist

• **Approach** (ET 01:14)

101. **(Teardrop entry is complete and pilot is going around the hold the first time and is rolling out inbound to JUGMO)** Set up cockpit to initiate approach to Martin State airport.

- *“Citation XXXX maintain 3000 until established. Cleared for the Runway 33 RNAV approach to Martin State circle Runway 15*
- *“Citation XXXXX readback is correct. Contact Martin State tower on 121.3 crossing CINDI.”*

102. Configure aircraft as per Cessna SOP

103. Initiate the approach

104. Level off at 2,000ft

105. Complete before landing flow

106. Complete before landing checklist

107. **(Aircraft reaching CINDI)** Report at CINDI & inbound:

- *79R contact Ground on 121.8*
- *“Citation XXXXX, circle north east, report beginning to circle, wind is 130 at 12, Runway 15 cleared to land.*

108. Descend to MDA

109. Reconfigure aircraft external lighting

110. Level off at MDA

111. Perform circle to land maneuver to Runway 15

- *“Roger.” (in response to pilot reporting initiating circle to land maneuver)*

112. Initiate descent from MDA

113. Turn final

114. Configure aircraft per Cessna SOP for landing

• **Landing** (ET 01:22)

115. Land airplane

116. Exit runway in accordance with turn-off plan

***** End of Task Analysis*****

117. ATC tells Citation XXXX to contact ground

- *“Citation XXXX, contact ground 121.8”*

118. Configure aircraft per Cessna SOP

119. Perform After Landing Checklist

• **Taxi In** (ET 01:24)

120. Obtain taxi clearance:

- *“Citation XXXX, where do you park?”*
- *“Citation XXXX, taxi right turn on Foxtrot to transient parking.”*

121. Taxi on taxiways to ramp

122. Monitor SAFE TAXI page on MFD (G1000)

- **Engine Shutdown** (*ET 01:29*)

123. Execute engine shutdown per Cessna SOP

124. Perform Shutdown Checklist (except last 2 items)

Estimated Time for Pre-flight Preparation: 25 minutes

Estimated Flight Time, including Cockpit Set-up = 1:29 Hours

Estimated Total Time = 1:54 Hours

2.2 High Level Overview of Experimental Flight Leg 2, KMTN-KHSP

2.2.1. Background

This is the second leg of a flight that originated in Teterboro, New Jersey. This leg is from Martin State Airport, near Baltimore, Maryland, to Ingalls Field at Hot Springs, Virginia. As with the first leg, it takes place during the hours of daylight in September on a moderate IFR day. The single pilot operator is the sole occupant and an IFR flight plan is filed. The aircraft is a Cessna 510 Citation Mustang equipped with a Garmin G1000 avionics suite and autoflight system. Following the cockpit setup and G1000 initialization, the flight is cleared to Ingalls Field via radar vectors to PALEO, the Nottingham (OTT) VOR and then as filed. Runway 15 is in use for departure, the initial altitude assigned is 2,000ft MSL, and a slight crosswind exists.

After a short taxi from transient parking, the flight departs Martin State. Although the departure procedure is a straight out climb on runway heading and relatively simple, the airspace in the D.C. Metroplex area is complex. Altitude restrictions are applied to avoid traffic conflicts and an expedited descent is required during climbout to accommodate another aircraft with an emergency. IMC is encountered during the initial climb. Once established en route with Washington Center, the flight evolves normally and is representative of a typical flight in the U.S. northeastern corridor. A relatively minor non-normal event occurs (the popping of a circuit breaker) which is expected to entail consultation of an abnormal checklist but should not require a diversion. Upon receipt of the AWOS for KHSP, the pilot prepares for a precision ILS approach where he or she will break out of the overcast approximately 600 feet above decision height. Another aircraft at KHSP is temporarily disabled on the runway forcing the study participant, if prudent, to go around or conduct the missed approach procedure. This leg terminates after the study participant completes a successful landing and taxis off the runway.

Principal G1000 Elements

- G1000 preflight initialization
- Flight plan entry
- Aircraft fuel and loading entries
- Communication and navigation radio tuning
- Taxi route identification and monitoring
- Database procedure selections
- Vertical and lateral navigation autoflight manipulation
- ‘Direct to’ FMS tasks
- Meeting crossing restriction prior to a waypoint
- Assessing fuel remaining at destination
- Dealing with an alerted, non-normal situation
- Precision approach execution
- Monitoring terrain during go around/missed approach

2.2.2. Aircraft Fuel and Weight

The airplane has a basic empty weight of 5,344 pounds and is re-fueled to its maximum of 2,580 pounds of fuel. The weight of the single pilot and baggage is 300 pounds and 45 pounds of fuel will be burned during taxi, yielding a takeoff weight of 8,179 pounds.

2.2.3. Flight Plan

An IFR flight plan is filed via J48 to KHSP at a true airspeed of 330 knots for an estimated time en route of 52 minutes at a requested altitude of FL200.

2.2.4. Phase of Flight Events

• Preflight Preparation at Aircraft (*Approximate Elapsed Time (ET) 00:00*)

01. Battery – CONNECT - deferred
2. Cockpit Preparation (cockpit set-up flow)– COMPLETE
3. Cockpit Set-up Checklist - COMPLETE
4. Lights – ON - deferred
5. Pitot Heat – ON 20 SECONDS, THEN OFF - deferred
6. Lights and Hot Items – CHECK - deferred
7. Lights – OFF - deferred
8. External Preflight – PERFORM - deferred
9. GPU – CONNECT
10. Battery – ON
11. Avionics Power – ON
12. G1000 Initialization
13. PFD Alert Messages – CHECK AND RESOLVE (G1000)
14. Fuel, Weight, and Performance Entries – COMPLETE
15. Takeoff Data – SET and ON
16. Copy ATIS – 124.925:

Martin State Airport Information INDIA 1353 Zulu automated weather, wind 120 at 8, visibility 3 miles in mist, 800 scattered, 1100 overcast, temperature 20, dew point 17, altimeter 29.88. RNAV approaches are in use. Landing and departing Runway 15. Notice to airmen: the ILS for Runway 33 is out of service. Readback all runway assignments and all hold short instructions. Birds are on and near the airport. Advise the Controller on initial contact you have information INDIA.

17. Request and Copy ATC airways clearance: 121.80
 - *“Citation XXXX is cleared to Hot Springs/Ingalls fly runway heading, radar vectors to PALEO, direct Nottingham (OTT), direct Casanova (CSN), J48, Montebello (MOL) direct. Maintain 2000. Expect FL200 15 minutes after departure. Potomac departure will be 119.0, Squawk 1623.”*
 - *“Citation XXXX read back correct.”*
18. Select departure procedure/departure waypoints from database (G1000)
19. Enter assigned route on MFD FPL page (G1000)
 - Select anticipated approach procedure from database (G1000)
21. Set communication frequencies (G1000)
22. Tune navigation radios and set courses (G1000)

23. Set initial heading and altitude (G1000)
24. Set transponder code (G1000)
25. Review minimums and obstacles departure procedures for KMTN
26. Review en route chart
27. Review destination airport charts [This isn't an approach brief, it's just a check to ensure they are all available.]
28. Complete Preflight Checklist

• **Engine Start** (*ET 00:15*)

29. Complete Before Start Checklist
30. Monitor engine parameters per Cessna SOP (G1000)
31. Complete After Start SOP
32. PFD Alert messages – check and resolve (G1000)

• **Taxi Out** (*ET 00:18*)

33. Configure aircraft per Cessna SOP
34. Confirm avionics set up – SAFE TAXI (G1000)
35. Confirm take off data (G1000)
36. CAS messages – check and resolve (G1000)
37. Complete Before Taxi Checklist
38. Request ATC taxi clearance – 121.8
 - *“Citation XXXX Taxi Alpha to Runway 15, hold short of Runway 15.”*
 - *“XXXX read back is correct”*
39. Confirm taxi routing on MFD (G1000)
40. Accomplish brake and flight control check
41. Taxi out
42. **(As aircraft turns onto taxiway alpha).** Request aircraft to contact tower.
 - *“Citation XXXX, switch to tower.”*
43. Change to tower frequency – 121.30
44. Complete Before Takeoff Checklist down to the line
45. Review Takeoff Checklist
46. Select desired climb mode (FD, HDG & ALT armed, G1000)
47. Engage flight guidance and navigation modes as necessary (G1000)

• **Takeoff** (*ET 00:25*)

48. **(Pilot lets ATC know he/she is ready for takeoff)** Contact tower – 121.30
 - *“Citation XXXX, line up and wait Runway 15.”*
49. Finish the Before Takeoff Checklist below the line
50. All Lights – ON
51. Windshield Heat – ON
52. Pitot Heat – ON
53. Taxi into position and wait on runway

***** Begin Task Analysis*****

54. **(Aircraft in position and waiting Runway 15)** Receive takeoff clearance and take off
- *“Citation XXXX wind is 120 at 8, maintain runway heading, climb and maintain 2,000ft, Runway 15, cleared for takeoff”*

55. Rotation at V_R

• **Climb (ET 00:26)**

56. Retract gear and flaps per Cessna SOP

- *Enter scattered clouds at 800ft*

57. **(Aircraft 800ft MSL)** Respond to tower hand-off to departure controller

- *“Citation XXXX contact Potomac Departure on 119.0.”*

58. Contact Potomac departure control

- *“Potomac Departure, Citation XXXX radar contact XXX ft. (alt.) Turn heading 190, maintain 2,000ft.”*

59. Turn to heading 190

60. Engage auto-flight as necessary (G1000)

61. Perform takeoff flow check

62. Complete after takeoff/climb checklist

63. Monitor climb to 2,000ft.

64. **(Aircraft is at 2,000ft MSL)** Respond to amendment to clearance

- *“Citation XXXX cleared direct PALEO then as filed. Maintain 2,000ft.”*

65. **(Aircraft is 2nm before PALEO)** Respond to amendment to clearance

- *“Citation XXXX cleared direct Nottingham (OTT), Maintain 2000ft.”*

66. **(Aircraft is 21nm before OTT)** Respond to ATC clearance

- *“Citation XXXX, climb and maintain 12,000’, contact Potomac Departure on 124.55.”*

67. Contact departure

- *“Roger XXXX, good morning.”*

68. **(Aircraft is at 7,000ft MSL)** Respond immediately to ATC instruction to descend

- *“Citation XXXX, descend immediately, maintain 6,000ft for emergency traffic.”*
(US Airways A320 with an electrical failure descending into Dulles)

69. **(Aircraft is 5 before OTT)** Respond to ATC clearance

- *“Citation XXXX, resume climb to 12,000ft. Contact Potomac Departure on 119.7.”*
- *“XXXX roger”(in response to Citation XXXX checking in with new controller)*

70. **(Aircraft reaches OTT VOR)** Respond to ATC clearance

- *“Citation XXXX, Climb and maintain FL200, leaving 17,000ft contact Washington Center on 133.9”*

71. Contact Washington Center

- *“Citation XXXX, roger, please verify the rest of your routing and your squawk”*
- *“XXXX, thank you.”*

72. Perform FL180 aircraft transition level check

73. Perform level off at cruise altitude

• **Cruise (ET 00:36)**

74. Complete cruise cockpit flow

75. Complete cruise checklist

76. Retrieve METAR via XM data-link (G1000)

76. (Alternate) Get METAR from flight watch (XM data-link unavailable)

- *(Pilot is before 15 NM before CSN when asking to go off frequency) “XXXX, report back on no later than 10 NM before CSN, frequency change to flight watch approved”*
- *(Alternate – if pilot is within 15NM of CSN when asking to go off frequency) – “Citation XXXXX, Unable frequency change at this time. For traffic descend and maintain 16,000 Culpeper altimeter 29.86.”*
- *“XXXX, Flight Watch, say time of arrival at Hot Springs”*
- *“XXXX stand-by”*

“Citation XXXX, current weather at HSP is wind 220 at 7, visibility 6, 1000 overcast, temperature 12, dew point 7, altimeter 29.84. Ummm, I don't have any PIREPS that are pertinent, and no forecast for Hot Springs but have a forecast for Lewisburg which is pretty nearby – that is Greenbrier Valley. Would you like to hear it?”

- *“XXXX, forecast for Lewisburg from 1200 Zulu until 1600 Zulu is wind 210 at 10, visibility greater than 6, ceiling at 6100 ft, no significant weather forecast for this period. Is there anything else I can help you with?”*
 - *“XXXX, do you have time to give me a PIREP?”*
 - *“XXXX, thank you very much”*
77. Report back on frequency with Washington Center
- *“XXXX roger”*
78. Prepare for arrival and approach to Runway 25 at KHSP
79. Tune and listen to AWOS for KHSP – 118.8

“Ingalls Field Airport Automated Weather Observation. XXXX Zulu Weather, wind 220 at 5, visibility 6 miles, 900 overcast, temperature 11 degrees Celsius, dew point 7, altimeter 29.84.”

80. Brief Approach to Runway 25 at KHSP

• **Descent (ET 00:51)**

81. **(Aircraft is 10nm before CSN)** (Pilot only gets this if he/she was not given this clearance earlier when left frequency to call flight watch.) Respond to ATC instruction
- *“Citation XXXX, for traffic descend and maintain 16,000, Culpeper altimeter 29.86.”*
82. Do descent flow
83. Complete descent Checklist
84. Complete FL180 transition checklist
85. Turn over CSN
86. **(Aircraft at CSN)** Respond to circuit breaker pop sound and CAS amber message:
ANTISKID FAIL
87. Monitor descent to 16,000ft
88. **(Aircraft at WITTO)** Respond to ATC instruction
- *“Citation XXXX, descend pilot's discretion cross 15 northeast of Montebello at one-zero, 10 thousand.”*
89. **(Aircraft at MITER begin lost pilot scenario, respond to ATC request to help with communication with lost aircraft)** Lost pilot scenario—see Study Script for exact verbiage as well as an alternate set of verbiage if the Mustang Pilot declines to help transmit comms between the lost pilot and Washington Center.
90. Monitor VNAV path intercept

91. Report leaving 16,000ft
 - *"Citation XXXX, roger"*
 92. **(Pilot reports to center controller that lost aircraft confirms instructions to switch to radio frequency 123.0)** End of lost pilot scenario – respond to instruction to change frequency
 - *"Citation XXXX, thanks for your help. Contact Washington Center on 134.4."*
 - *"XXXX, roger"*
 93. Monitor descent to 10,000ft
 94. **(Aircraft is 10 NM before MOL)** Respond to controller's clearance
 - *"Citation XXXXX, you can expect the ILS approach Runway 25 at Ingalls Field, Advise when you have the weather"*
[(Only available when aircraft is within 50NM of KHSP) - "Ingalls Field Airport Automated Weather Observation. XXXX Zulu Weather, wind 230 at 6, visibility 5 miles, 1000 overcast, temperature 11 degrees Celsius, dew point 7, altimeter 29.84.]
(Aircraft reports has one minute weather) "Citation XXXX, roger"
 95. **(Aircraft is at MOL)** Turn at Montebello
 - *"Citation XXXXX, 17 miles from IFAVU, proceed direct to IFAVU, maintain 8000 until IFAVU, cleared for the straight-in ILS Runway 25 approach at Hot Springs"*
 - *"Citation XXXX, read back correct"*
 96. Complete approach checklist
- **Approach (ET 01:20)**
 97. Monitor crossing IFAVU and initiate descent to 6,000ft
 98. Monitor descent to 6,000ft
 99. Configure aircraft per Cessna SOP for approach
 100. Monitor turn at AHLER
 101. Intercept glide slope
 102. Complete landing flow
 103. Complete before landing checklist
 104. **(Aircraft at final approach fix (DURAN/outer marker))** Respond to ATC instruction to change CTAF frequency – 123.0
 - *"Citation XXXXX, radar service is terminated, frequency change to advisory approved, report canceling IFR on this frequency in the air or on the ground with Leesburg flight service on 122.0"*
 (Break out of clouds at 4,788ft MSL / 996 AGL)
 105. Make decision about whether to proceed for landing visually
 106. **(Aircraft at 4,600ft MSL)** Monitor aircraft on the field
 - *"Ingalls traffic, Malibu 6349L on the active. My engine just quit. I will restart and exit the active as quickly as possible. Ingalls"*
 107. **(Aircraft at 4,280ft MSL)** Make decision about how to proceed for landing
 - *"Ingalls traffic, Malibu 6349L engine restarted. Exiting runway at next taxiway, Ingalls"*
 108. **(90sec after 6349L reports engine restarted)** Decide to take precautions and go around in the pattern or fly missed approach procedure
 - *"Malibu 49L, clear of Runway 25, Ingalls"*
 109. Fly aircraft on final
 - **Landing (ET 01:25)**
 110. Land airplane
 111. Exit runway in accordance with turn-off plan and report clear of active.

- 112. Configure aircraft per Cessna SOP
- 113. Perform After Landing Checklist

• **Taxi In** (*ET 01:27*)

- 114. Taxi on taxiways to ramp
- 115. Monitor SAFE TAXI page on MFD (G1000)
- 116. Cancel IFR clearance with flight service station
 - *“Roger XXXX, on the ground at Hot Springs, your IFR is cancelled, have a good day”*
(If they choose to cancel IFR clearance while airborne, then the verbiage will be *“Roger XXXX, your IFR is cancelled squawk 1200, have a good day”*)

• **Engine Shutdown** (*ET 01:32*)

- 117. Execute engine shutdown per Cessna SOP
- 118. Perform Shutdown Checklist (except last 2 items)

• **Securing** (*ET 01:35*)

- 119. Complete Secure or Parking Checklist

Estimated Time for Pre-flight Preparation: 25 minutes
Estimated Flight Time, including Cockpit Set-up = 1:35 Hours
Estimated Total Time = 2:00 Hours

3. Analyses of Discrete Scenario Tasks

The task analysis of Experimental Flight Leg 1, KTEB–KMTN, is shown in Appendix A-1 (pages 18–58). The task analysis of Experimental Flight Leg 2, KMTN–KHSP, is shown in Appendix A-2 (pages 59–100).

4. Concurrent Task Timelines

As described earlier, the concurrent tasks timelines were developed to illustrate how the discrete scenario tasks and subtasks identified in the task analyses (as well as continuous tasks such as monitoring the status of cockpit instruments) might be completed concurrently and interleaved during a real flight. These timelines were used to confirm segments of the flights likely to contain high workload to focus later analysis of the simulation study data.

On the concurrent task timelines (see Appendix B, pages 101–154) each scenario was broken down into two-minute increments with each page illustrating the tasks being completed during each increment. The tasks and subtasks are grouped in four different categories: 1) tasks involving the use of the Garmin G1000 avionics suite aboard the aircraft; 2) tasks involving communication with ATC, other pilots, and setting up and using the radios; 3) monitoring tasks, including on-going monitoring such as a scan of cockpit instruments; and 4) manual flying tasks. All subtasks are coded the same color as the higher-level task of which they are a part to make it easier to identify tasks and subtasks that go together when they are split up across the four different categories on the page.

The color selected for the different tasks and subtasks was arbitrarily chosen to distinguish a task, and its associated subtasks, from others that also appeared on the same page. The high level (main) tasks

are titled in bold capitalized text whereas the subtask titles are not bolded and contain both upper and lower case text.

The width of each task or subtask box on the timelines corresponds with the amount of time our Cessna Citation SME would have taken to perform that action. A ‘window in time’ exists for when some actions can be accomplished (e.g., check the destination airport automation weather information). To illustrate this, we used black arrows extending from the sides of the box. The location of the box itself (as well as its size) indicates when our SME would have completed the task or subtask and how long it would have taken. The tips of the two black arrows extending from the sides of the box indicate the edges of the ‘window in time’ during which this ‘floating action’ could be completed.

4.1 Concurrent Task Timeline for Experimental Flight Leg 1, KTEB-KMTN

The Concurrent Task Timeline of experimental flight leg 1 is shown in Appendix B-1 (pages 101–126).

4.2 Concurrent Task Timeline for Experimental Flight Leg 2, KMTN-KHSP

Insert of Concurrent Task Timeline of experimental flight leg 2 is shown in Appendix B-2 (pages 127–154).

5. References

- Burian, B. K., Pruchnicki, S., & Fry, D. G. (2013). Entry-Level Jet Single-Pilot Human-in-the-Loop Simulation Research: Study Scripts and Radio Background Chatter Dialogue. NASA Technical Memorandum, NASA/TM—2013-216575.
- Burian, B. K., Pruchnicki, S., Rogers, J., Christopher, B., Williams, K., Silverman, E., Drechsler, G., Mead, A., Hackworth, C., & Runnels, B. (2013). Single Pilot Workload Management in Entry-Level Jets. NASA Technical Memorandum, NASA/TM—2013–216557.
- Loukopoulos, L. D., Dismukes, R. K., & Barshi, I. (2009). The multitasking myth: Handling complexity in real-world operations. Burlington, VT: Ashgate.

Appendix A-1. Scenarios for Flight Leg 1

Phase of Flight	Trigger	High Level	ATC / ATIS / AWOS	Radios	First Level/Task Descriptor	Second Level	Third Level	Fourth Level	Notes	# physical steps (6 more notes)
	Pilot calls for Clearance	Request and copy ATC Clearance 128.05	Chilton XXXXX is cleared to the Martin State Airport via the Teleport 6 Departure, rear radios B(G)1, JTS, MU/PPH, Baltimore Direct. Maintain 1,500 until passing the TEB 4.5 DME. Then climb and maintain 2,000. Expect FL200 10 minutes after departure. New York Departure on 126.7. Squawk 3405.	Com1 Active: CTRBL Com1 Standby: Ground Com2 Backup: TEB ATIS Com2 Standby: Guard						
		Select Departure Procedure from database. (G1000)								
		Enter assigned route on MFD FPL page. (G1000)								
		Select anticipated approach procedure from database (G1000)								
		Set communication frequencies (G1000)								
		Tune navigation radios and set courses (G1000)								
		Set initial heading and altitude (G1000)								
		Set transponder code (G1000)								
		Review departure procedure								
		Review enroute chart								
		Review destination airport charts							This isn't an approach chart, it's just a check to ensure they are all available	
		Complete Preflight Checklist								
		Complete Before Start Checklist								
		Monitor engine parameters per Cessna SOP (G1000)								
		Complete After Start SOP								
		PF/D Alert messages - check and resolve (G1000)								
		Configure aircraft per Cessna SOP								
		Confirm avionics set up - SAE TAXI (G1000)								
		Confirm take off data (G1000)								
		CAS messages - check & resolve (G1000)								
		Complete Before Taxi Checklist								
		Request ATC taxi clearance - 121.9								
	Chilton XXXXX contacts ground for taxi clearance								Unknown if guard will be monitored on Com 2. However, 9/11 NORTAS state or suggest monitoring guard if possible. Interested to see if our subjects do.	
		Confirm taxi routing on MFD (G1000)								
			Chilton XXXXX, taxi Papa, Lima, hold short of runway 19. Expect runway 24 intersection departure at runway 19. Monitor tower holding short of 19	Com1 Active: Ground Com1 Standby: Tower Com2 Backup: TEB ATIS Com2 Standby: Guard						

Phase of Flight	Trigger	High Level	ATC / ATIS / AWOS	Radios	First Level/Task Descriptor	Second Level	Third Level	Fourth Level	Notes	# physical steps (8 more notes)
		46 Accomplish brake and flight control check			Taxi on taxiway Papa					
		47 Taxi out			Taxi on taxiway Lima					
		48			Hold short of runway 19					
		49								
		50								
		51 Complete Before Takeoff Checklist down to the line								
	Clatton XXXXX switches from ground control to tower frequency	52 Switch to tower frequency		Com1 Active: Tower Com1 Standby: Departure Com2 Backup: Guard Com2 Standby: TEBATIS						
		53								
		54 Review Takeoff Checklist								
		55 Select desired climb mode (FD, HDG & ALT engaged, G1000)								
		56 Engage flight guidance and navigation modes as necessary (G1000)							Command bars and nav mode. Auto pilot off. 1500ft. Is set in altitude window. Traffic display is up on MFD. Turn on all lights before taking runway (taxi/landing, rotating beacon (is already on), anti-collision (strodes), nav lights (also already on), wing inspection light	
		57								
Take Off										
	Pilot lists ATC know they are ready for Takeoff	58 Obtain ATC takeoff clearance - 119.5		Com1 Active: Tower Com1 Standby: Departure Com2 Backup: Guard Com2 Standby: TEBATIS						
		59 Finish Before Takeoff Checklist (below the line)								
		60 All Lights - ON								
		61 Windshield heat - ON								
		62 Pilot head - ON								
		63 Taxi on to runway 24 lines up and waits in position								
		64								
BEGIN TASK ANALYSIS										
	aircraft in position and holding on runway 24, KTEB	65 Receive takeoff clearance and take off		Com1 Active: Tower Com1 Standby: Departure Com2 Backup: Guard Com2 Standby: TEBATIS	ATC clears pilot to take off					
		66								
		67			Read back clearance					
		68								
		69								
		70			Hot Items on					
		71								
		72			Lights					
		73								
		74								

Phase of Flight	Trigger	High Level	ATC / ATIS / AWOS	Radios	First Level/Task Descriptor	Second Level	Third Level	Fourth Level	Notes	# physical steps (& more notes)
					Turn strobes off	Flap anticollision switch down				
					Turn landing/taxi lights off	Flap landing/taxi lights down to off position				
	pilot determines when	Engage autoflight as necessary (G1000)			Press AP button on autopilot	Verify AP mode on PFD			this is concurrent with flying the departure	
	pilot determines when	Perform takeoff flow check			Set climb power	Reduce throttle to climb detent	Verify green CLIM on PFD			
					Verify flaps up	Check flap handle position up				
					Check pressurization	Verify pressure differential on MFD				
					Verify gear up	Check gear handle position up	Verify transit light out			
						Check not lems on heat				
						Check left/right windshield heat				
						Check pitot/static heat on				
	aircraft reaches 1300 ft. MSL	Change frequency and check in with Departure controller								
			Citation XXXXX contact departure 126.7"	Com1 Active: Tower Com2 Standby, Departure Com3 Standby, TEB ATIS	AT C gives pilot frequency change	pilot listens				
					Pilot acknowledges instruction to contact departure				"departure on 126.7, fly the TEB 6. XXXXX"	
						press push to talk			freq = 126.7	
					verify departure frequency just given is what is in standby for COM 1					
					Identify which radio is in use				active frequency tek is green (blue box around standby freq.) if you want to tune the other radio, press the COM knob once	
						press <- button	check that the active frequency is now 126.7			
					Pilot presses push to talk and Contacts NY Departure					
				Com1 Active: NY Com1 Standby: TEB Tower Com2 Standby: TEB ATIS	AT C acknowledges contact	press push to talk			NY Departure, Citation XXXXX . 1300 climbing 1500"	
	Pilot checks in with departure controller		Citation XXXXX NY Departure radar contact XXXX ft. (all)	Com1 Standby: TEB Tower Com2 Standby: TEB ATIS	AT C acknowledges contact					

Phase of Flight	Trigger	High Level	ATC / ATIS / AWOS	Radios	First Level/Task Descriptor	Second Level	Third Level	Fourth Level	Notes	# physical steps (6 more notes)
		151								
		152			decide want to monitor Guard frequency (121.5)	pilot listens				
		153				Verify that Guard Frequency is entered as Com2 Backup frequency press COM2 button on the audio panel				
		154		Com1 Active: NY						
	aircraft reaches 1500 ft. MSL	155		Departure Com1 Standby: TEB Tower Com2 Monitor: Guard Com2 Standby: TEB ATIS						
		156			Level off at 1500 feet				Adopt pilot automatically goes into altitude mode	
		157			Monitor level off at 1500 MSL					
		158			Reduce power					
		159				Reduce throttles to maintain less 200knts				
		160					Monitor magenta trend line			
		161					Monitor airspeed changes			
		162			verify altitude capture					
		163			monitor pitch change	verify green ALT mode on PFD				
		164								
		165			note the time				you are allowed to continue to accelerate in cruise using climb power for 10 minutes - need to keep track of time	
		166			aircraft reaches 1500 ft. MSL				adhere to 1500' MSL turn and distance requirement then 2000' MSL altitude restriction	
		167			Monitor first departure turn					
		168			Right turn at 1500 MSL to Heading (HDG) 280	monitor bank to the right to follow command bars				
		169			Monitor roll out on HDG 280					
		170				Aileron and rudder to left to follow command bars				
		171			Monitor TEB 4.5 DME	Monitor DME window on PFD				
		172								
	aircraft is at 4.5 DME	173			Initiate climb					
		174			Select 2000ft. in altitude window					
		175				Turn altitude select knob so that 2000ft. is shown on PFD				
		176			Set climb power	Move throttle forward to climb detent				
		177								
		178					Verify green CLIM on MFD			
		179			Press ALT button on autopilot				disables altitude mode and puts you in pitch mode.	
		180							will differ per pilot	
		181			Select 5 degrees nose up					
		182				Turn auto pilot pitch wheel down (back end of wheel downward)				
		183			Complete after takeoff/climb checklist				Concurrent task that will be done while climbing to 2000ft. will be completed after 2000ft. level	completing procedures & make sure the A/C is set up as it should be

Phase of Flight	Trigger	High Level	ATC / ATIS / AWOS	Radios	First Level/Task Descriptor	Second Level	Third Level	Fourth Level	Notes	# physical steps (8 more notes)
		184			remember need to complete the TO xlist get the Xlist card out					
		185			1. Landing gear				reading from card & checking on the panel	
		186			2. Flaps	Up, done				
		187			3. Throttles	Up, done				
		188			4. Yaw damper	Power set				
		189			5. Anti ice systems	On, done				
		190			6. PAX safety switch	Off, done			RAT is around 25C (Celsius) - this step is performed as a read-and-do, not considered earlier as part of the flow	
		191			7. Landing lights	Off, done			Done during preflight	
		192			8. Pressurization	Off, done			turned off when entered clouds	
		193			9. Altimeters	checked, done				
		194				say to self - it is set for lower altitude levels				
		195				know that you've planned this flight to go above 18000 ft.				
		196				know that you will have to reset this later				
		197			Take off/climb checklist complete					
		198			put card away in an easily retrievable place					
		199								
		200								
		201								
		202								
		203								
		204								
		205								
		206								
		207								
	aircraft reaches 2000 ft. MSL	208			Monitor climb to 2000ft. MSL					
		209			Note flash of altitude reading two hundred feet before 2000 ft.					
		210			Monitor level off at 2000ft.					
		211				Monitor altitude tape and blue bug				
		212			Reduce power	Adjust throttles to maintain less than 200kts				
		213				Monitor magenta trend line.				
		214				Monitor airspeed changes				
		215								
		216			verify altitude capture	verify green ALT mode on FTD				
		217			monitor pitch changes					
		218								
		219			note the time				you are allowed to continue to accelerate in climb using climb power for 10 minutes - need to keep track of time	
		220			Respond to ATC traffic call					
	Aircraft is 10 DME from TEB	221			Clarton XXXXX, you have crossing traffic, 2 o'clock and ten miles at 4000, an United 737 going to LaGuardia	Com1 Active: NY Departure Com1 Standby: TEB Tower Com2 Monitor: Guard Com2 Standby: TEBATIS	ATC informs pilot of crossing traffic		8737	

Phase of Flight	Trigger	High Level	ATC / ATIS / AWOS	Radios	First Level/Task Descriptor	Second Level	Third Level	Fourth Level	Notes	# physical steps (8 more notes)
		249								
		250			2. pilot dials in heading 270 on mode control panel	turn heading knob			check that the active frequency is now 132.8	
		251				Select heading mode			freq check	
		252							begin to execute the clearance 1 G1000 step because 3/6/15 is requested	
		253				Press heading button on autopilot			270 degrees	
		254				Verify by checking heading mode on PFD				
		255			monitor the a/c beginning to turn				starting turn	
		256			monitor that your heading is beginning to align with the bug on the HSI	Verify through aircraft banking visual and physical indicators			(task 1 set up & in progress)	use AP tools to help monitor turn
		257								
		258			3. pilot sets altitude window on PFD to 6,000 using mode control panel knob				concurrent task during this section to monitor heading and ensure heading capture at 270	
		259				remember 2nd action given by ATC			maybe refer to written clearance	
		260				set ALT on PFD				
		261				twist ALT SEL knob on mode control panel - verifying altitude as you complete this step since you are looking altitude tape while completing this action			6000' - setting climb	4 G1000 steps to go into VS mode and begin climb to new alt. = easy but different than selecting heading (don't press the ALT knob as you do with HDG knob)
		262				Set climb power				
		263				Move throttles all the way up to climb detent				
		264				Verify CLM green on power tape on the MFD				
		265				Press ALT button on mode control panel.				
		266				Set 10 degrees nose up pitch				
		267								
		268				Turn pitch wheel on mode control panel				
		269							watch for pitch up and airspeed decrease	starting climb
		270				When airspeed equals 170knts press F.C button on mode control panel				
		271				monitor airspeed				
		272				monitor a/c climbing			need to see that the airspeed remains in place are now watching for outcome	monitoring
		273								
		274				4. contact NY approach				
		275				remember that you've set radios up for call but still need to contact ATC				
		276				contact NY Approach				
		277							New York Approach, Clearance xxxxx, xxx (altitude) climbing 6,000'	SA for ATC
	Pilot makes contact with NY Approach Controller	278								double check

Phase of Flight	Trigger	High Level	ATC / ATIS / AWOS	Radios	First Level/Task Descriptor	Second Level	Third Level	Fourth Level	Notes	# physical steps (6 more notes)
	pilot decides when	Build course to intercept BVLZ 208 radial and then to BIGGY								
280					Select flight plan					
281						press FPL button on center console				
282					Activate cursor					
283					move cursor to highlight BIGGY on Flight plan	press FMS button				
284					Press direct button on center console					
285						note direct BIGGY highlighted				
286					Press enter					
287					Go into OBS mode					
288						Press OBS button on PFD				
289										
290					Twist course CRS knob on auto pilot console to select 208 direction					
291						Note CDI is in front of aircraft				
292					Activate intercept	press NAV button mode control panel				
293										
294					Deactivate cursor					
295						press FMS button on center console			Needs to be done FMS cursor is activated. It needs to be deactivated.	
296					Return to Leg Mode				this is necessary in order for the flight plan to sequence to the next step in the flight plan - next waypoint after BIGGY	
297						press the OBS button on the PFD				
298					bring traffic display back up on MFD	press FPL button on center console				
299										
300	Aircraft is at 5,000 ft. MSL	Monitor climb to 6000ft.								
301					at 5,000 ft. hear altitude chime	look at altimeter				
302									verify (audibly) "5,000 climbing 6,000" while pointing	
303										
304					200 ft. before 6,000 ft. note flashing and reverse lighting of altitude preselected number at the top of the altitude tape					
305					note reduction in Vertical speed					
306					note increase in indicated airspeed					
307					verify altitude capture					
308						Pilot notes normal video on PFD altitude selection display				
309						verify green ALT mode on PFD				
310					monitor pitch change					
311					note the time				you are allowed to continue to accelerate in cruise using climb power for 10 minutes - need to keep track of time	
312					reduce power					

Phase of Flight	Trigger	High Level	ATC / ATIS / AWOS	Radios	First Level/Task Descriptor	Second Level	Third Level	Fourth Level	Notes	# physical steps (8 more notes)
		313				note speed is at 180 KIAS				
		314				Adjust throttles to keep airspeed below 200 KIAS				
	Aircraft reaches TEB 30 DME (clear of traffic)	315	Respond to revised clearance from ATC							
		316		Com1 Active: NY Departure Com1 Standby: NY Com2 Monitor: Guard Com2 Standby: TEB ATIS	ATC confirms pilot clearance for route of flight					
		317				Pilot listens to clearances				
		318				Recall or write down				
		319			pilot reads back ATC clearance					
		320				Press push to talk				
		321		Com1 Active: NY Departure Com1 Standby: NY Com2 Monitor: Guard Com2 Standby: TEB ATIS	ATC confirms read back correct					
		322				pilot listens				
		323			pilot thinks about task					
		324				this is not the clearance the pilot expected				
		325				Pilot understands that instruction and realizes some instructions can be executed concurrently (climb and communicating)				
		326				Decides to enter in radio frequency and then make radio call while completing other tasks				
		327				1. entering radio frequency				
		328				read the frequency				
		329				identify which radio is in use				
		330				tune in standby using big knob...				
		331				and little knob				
		332				activate frequency				
		333				Press <- button				
		334				check that the active frequency is now 135.45				
		335			2. selecting direct to BIGGY					
		336				press Direct button on center console				
		337				verify "Direct" to BIGGY is highlighted				
		338				press enter				

Phase of Flight	Trigger	High Level	ATC / ATIS / AWOS	Radios	First Level/Task Descriptor	Second Level	Third Level	Fourth Level	Notes	# physical steps (8 more notes)
		339				look at autopilot status bar on PFD	look to see that status has gone from HDG to GPS mode			
		340							through aircraft banking, visual and physical indicators	starting turn
		341				monitor the a/c beginning to turn			(task 1 set up & in progress) horizontal situation indicator	use AP tools to help monitor turn
		342				monitor that your heading is beginning to align with the bug on the HSI			concurrent task during this section to monitor heading and ensure heading capture at 280	
		343			3. pilot sets altitude window on PFD to 20,000 using mode control panel knob				maybe refer to written clearance	4. G1000 steps to go into VS mode and begins climb to new alt. = easy but different than selecting heading (don't press the ATC knob as you do with HDG knob)
		344				remember 2nd action given by ATC				
		345				set ATC on PFD using mode control panel knob				
		346								
		347				Set climb power				
		348								
		349						Verify by checking green CLM on MFD		
		350				Press altitude button on mode control panel.				
		351				roll pitch wheel to show 10 degrees nose up.	Verify pitch mode on PFD			
		352					watch for pitch up and airspeed decrease			starting climb
		353								
		354					When airspeed equals 170kts press FLC button on mode control panel			
		355					Verify in FLC mode on PFD			
		356				monitor airspeed			need to see that the airspeed stays the same	monitoring
		357				monitor for a/c climbing			concurrent	maneuver is in place are now watching for outcome
		358				4. contact NY approach			this is concurrent with steps 2 and 3 above	
		359					remember that you've set radios up for call but still need to contact ATC			
		360				pilot contacts NY Approach			SA for ATC	
		361							"New York Approach, Citation XXXXX, xxxx (altitude) climbing FL200"	
	Pilot makes contact with new NY Center controller	362			Com1 Standby, NY Com2 Monitor, Guard Com3 Standby, TEB ATIS	ATC has radar contact with XXXXX				
		363				Pilot acknowledges instructions				
		364								
		365							Maintain FL200 - report reaching	
	Aircraft reaches 18,000 ft. MSL	366				Press push to talk			29.92 on altimeter, press/radiation check, set destination field elevation	
		367				Set PFD altimeter to 29.92				

Phase of Flight	Trigger	High Level	ATC / ATIS / AWOS	Radios	First Level/Task Descriptor	Second Level	Third Level	Fourth Level	Notes	# physical steps (6 more notes)
		368								
		369				push Baro button on PFD verify "STD BARO" on PFD at bottom of ALT tape			hard dedicated button on side of screen	
		370			Set Standby altimeter to 29.92					
		371				Twist standby ALT knob to read 29.92				
		372			Check pressurization	verify cabin altitude				
		373								
		374					look at tape on MFD - triangle should be pointing within green section			
		375				verify cabin differential				
		376					look at number above cabin Altitude tape on MFD - should be green			
		377			Verify that landing/taxi lights are off					
	Aircraft reaches FL190	378	Monitor climb to FL200		at 19,000 ft. hear altitude chime	look at altimeter	verify (audibly) "190 climbing 200" while pointing			
		379								
		380								
		381								
		382			200 ft. before FL200 note flashing and reverse lighting of altitude preset number at the top of the altitude bug					
		383			note reduction in vertical speed					
		384			note increase in indicated airspeed					
		385			verify altitude capture					
		386				Pilot notes normal video on PFD altitude selection display				
		387			monitor pitch changes	verify green ALT mode on PFD				
		388			note the time					
		389							you are allowed to continue to accelerate in cruise using climb power for 10 minutes - need to keep track of time	
	Aircraft reaches BIGGT intersection	390	Monitor reaching first waypoint on route							
		391			Monitor aircraft turn at BIGGT					
		392			Check that BIGG/COPES legs is active					
		393								
		394				Look at bracket on flightplan on MFD or top of PFD				
Cruise	Aircraft reaches FL200	395	Report reaching FL200 to ATC							
		396			remember that you are to report reaching FL200 to ATC					
		397				pilot contacts ATC and reports reaching				
		398					Press push to talk		"NY Center, Claton XXXX, FL200"	

Phase of Flight	Trigger	High Level	ATC / ATIS / AWOS	Radios	First Level/Task Descriptor	Second Level	Third Level	Fourth Level	Notes	# physical steps (6 more notes)
		429			put checklist card away					
		430			back on glareshield Think about "what is next to be done?"					
	pilot decides when	431								
		432			(Select waypoints on MFD)					
		433			turn large FMS knob on center console to highlight waypoint chapter		see waypoint chapter highlighted on MFD			
		434			turn small FMS knob to highlight airport page		see far left page in Waypoint chapter get highlighted		KMNTN should be displayed - if not then have to press FMS knobs to select KMNTN	
		435			press WX softkey on MFD				4th key from the right	
		436								
		437								
		438								
		439			Evaluate weather and winds	Compare winds to runway	Note that the winds favor runway 15			
		440								
		441								
		442				Pull out approach plates and airport diagrams	Note: ILS to runway 15			
		443								
		444								
		445								
		446				Compare visibility to approach requirement	Plan on ILS to runway 33			
		447				Compare ceiling to approach minimums	Note visibility is greater than the required 1 mile			
		448								
		449				Note temperature dew point spread	Note 1000ft. is greater than the 400ft. required			
		450				Note that runway should be wet	Note spread is less than 4 degrees therefore chance of fog forming			
		451								
		452								
		453								
		454								
		431	Get METAR from Flight Watch (XM data link not available)		Clip approach plate and airport diagram to yoke				note that you have a crosswind note that METAR says you have mist and that runway is likely to be wet	
	pilot decides when	432			Select waypoints on MFD					

Phase of Flight	Trigger	High Level	ATC / ATIS / AWOS	Radios	First Level/Task Descriptor	Second Level	Third Level	Fourth Level	Notes	# physical steps (6 more notes)
		452				decide to monitor COM 1 for the time being, just don't want to transmit			leave COM1 button on the radio panel "ON"	
		453		Com1 Monitor: NY Center Com1 Standby: NY Departure Com2 Active: Flightwatch Com2 Standby: Guard	Make contact with Flightwatch	press push to talk			"Flightwatch, Cleaton XXXXX (flight level 200 location) request weather update for MTN"	
		442								
		ALT								
	Pilot contacts Flight Watch	454	"Cleaton XXXXX, Flightwatch, say time of arrival at Martin State	Com1 Monitor: NY Center Com1 Standby: NY Departure Com2 Active: Flightwatch Com2 Standby: Guard	Flightwatch asks pilot question	press push to talk				
		455			Respond to Flightwatch questions	press push to talk				
		443								
		ALT								
		456			Respond to Flightwatch questions	compute arrival time				
		457					Press FPL button on center console			
		444					Press FMS knob on center console			
		ALT					Scroll to highlight KMTN			
		458					Turn large FMS knob on center console			
		459								
		445					Read cumulative ETE remaining			
		ALT					Read current GMT on PFD			
		460					Add the GMT and cumulative ETE giving you arrival time			
		461								
		446				press push to talk			Say arrival time XXXXX	
		ALT								
	Pilot reports estimated time of arrival at KMTN	462	" Cleaton XXXXX, standby..."	Com1 Monitor: NY Center Com1 Standby: NY Departure Com2 Active: Flightwatch Com2 Standby: Guard	Flightwatch tells pilot to standby while information requested is relieved	press push to talk				
		463				press push to talk				
		447	"Cleaton XXXXX, current weather at Martin State is wind 120 at 13, visibility 3 miles with mist, 800 scattered, 1000 overcast, temperature 18, dew point 16, altimeter 29.89. No PREPS. Forecast for Martin State from 1200 Zulu until 1600 Zulu, wind 120 at 5 visibility 5 miles, 1500 foot overcast. No precipitation. Conditions to improve slightly later this afternoon. Is there anything else you need?"	Com1 Monitor: NY Center Com1 Standby: NY Departure Com2 Active: Flightwatch Com2 Standby: Guard	Flightwatch gives pilot requested weather information	press push to talk				
	20 seconds after Flight Watch Briefer tells pilot to standby	447								
		ALT								
		464				press push to talk				
		465			Respond to Flightwatch questions	press push to talk			"No, that's all. Thanks, XXXXX"	
		448								
		ALT								
	Pilot says he/she has all info needed	466	"Cleaton XXXXX, do you have time to give me a PIREP"	Com1 Monitor: NY Center Com1 Standby: NY Departure Com2 Active: Flightwatch Com2 Standby: Guard	Flightwatch asks pilot for a PIREP	press push to talk				
		467				press push to talk				
		449			Respond to Flightwatch questions	press push to talk			"Affirmative XXXXX standby"	
		ALT								
		488			Assemble PIREP					
		469				Determine winds				
		450								
		ALT								

Phase of Flight	Trigger	High Level	ATC / ATIS / AWOS	Radios	First Level/Task Descriptor	Second Level	Third Level	Fourth Level	Notes	# physical steps (8 more notes)
		470					Look at wind vector on PFD			
		471				Determine air temperature				
		451 ALT				Consider clouds	Look at RAT			
		472				Consider turbulence				
		452 ALT								
		474				Give PIREP				
		475				press push to talk				
		475							"XXXXX" wind, XXXX, RAIN, air temperature XX, IMC, negative turbulence, XXXX is a EC-510"	
		453 ALT								
	Pilot finishes giving PIREP	476								
		477								
		454 ALT								
		478								
		479								
		455 ALT								
		480								
		481								
		456 ALT								
	Pilot reports back on frequency	482								
		483								
		457 ALT								
		484								
		485								
		458 ALT								
		486								
		487								
		459 ALT								
		488								
		489								
		460 ALT								
		490								
		491								
		461 ALT								

Phase of Flight	Trigger	High Level	ATC / ATIS / AWOS	Radios	First Level/Task Descriptor	Second Level	Third Level	Fourth Level	Notes	# physical steps (6 more notes)
		492								
		493								
	When aircraft reaches COPES intersection	454	Get and respond to ATC call with re-route							
		455	Citation XXXXX, I have an amendment to your routing. Advise when ready to copy.	Com1 Active: NY Center Com1 Standby: NY Com2 Monitor: Guard Com2 Standby: Flightwatch	ATC contact pilot and tells pilot will be re-routed					
		456								
		457								
		458								
		459								
	When Pilot indicates that his/she is ready to copy re-route	460	Citation XXXXX is now cleared to Martin State Airport via J75, Modena (MKE), direct DuPont (DQD), Victor 214 to KERNQ, direct to JUGW/D, direct Martin State	Com1 Active: NY Center Com1 Standby: NY Com2 Monitor: Guard Com2 Standby: Flightwatch	ATC gives new clearance (re-route)					
		461								
		462								
		463								
		464								
		465	Citation XXXXX, read back correct. Cross DuPont at or below 17,000. Maintain 12,000. Philadelphia altimeter is 29.89	Com1 Active: NY Center Com1 Standby: NY Com2 Monitor: Guard Com2 Standby: Flightwatch	ATC confirms read back is correct and adds altitude and frequency change					
	Pilot reads back clearance correctly	466								
		467								
		468								
		469								
		470								
		471								
		472								
		473								
	pilot decides when	474	Input re-route into flight-plan							

Phase of Flight	Trigger	High Level	ATC / ATIS / AWOS	Radios	First Level/Task Descriptor	Second Level	Third Level	Fourth Level	Notes	# physical steps (6 more notes)
	475				Modify Existing Flight Plan					
	476				press FPL button on MFD keypad				begin to change the fl	
	477				Looks at current flight plan				J75.MURPH COPES MXE STOEN SACRI MURPH	
	478						realizes that needs to be quick or will not finish reprogramming flight plan by the time aircraft arrives at MXE		If DDO is not put in before reaching MXE then G1000 will cause aircraft continue onto MURPH and not make turn at MXE	
	479				press FMS knob to activate cursor				two steps - scroll and press	set up new plan
	480				Use large FMS knob to scroll down to STOEN					
	481				Type DDO					
	482									
	483						Confirm DDO has been added to the flight plan		This action makes sure aircraft is heading in right direction when you get to MXE	
	484						Verify cursor is on STOEN	Verify by looking at flight plan on MFD		
	485									
	486				Delete STOEN				As each point on the flight plan is deleted the cursor moves down to the next one in sequence, so it is not necessary to reposition the cursor on the next step. A simple "repeated" sequence of "Clear", "Enter" will delete each of the subsequent waypoints.	
	487									
	488									
	489									
	490				Delete SACRI					
	491									
	492				Delete MURPH					
	493									
	494									
	495				Delete BAL					
	496									
	497									
	498									
	499				Turn small FMS knob 1 click clockwise				This action brings up empty text window on MFD in flight plan. And activates the lead arrow, so they on lower right portion of MFD	
	500				Press leadaway (LD ARWAY) so they scroll down and highlight VZ14				brings up list of airways from DDO	
	501				Use large FMS knob to scroll down and highlight KERNO				This action selects VZ14 as airway desired off DDO	
	502									
	503								This action selects exit point off of VZ14	
	504									
	505									
	506				Deactivate cursor					

Phase of Flight	Trigger	High Level	ATC / ATIS / AWOS	Radios	First Level/Task Descriptor	Second Level	Third Level	Fourth Level	Notes	# physical steps (6 more notes)
	pilot decides when	Do descent flow								
		538								
		539			Reduce Thrusties as required					
		540			Remember that you have airport ATIS Remember that approach is entered in flight plan and that approach is briefed					
		541			Set landing bugs					
		542								
		543								
		544								
		545								
		546								
		547								
		548								
		549								
		550								
		551								
		552								
		553								
		554								
		555								
		556								
		557								
		558								
		559								
		560			Activate landing bugs					
		561								
		562								
		563								
		564								
		565								
		566								
		567								
		568								
		569								
		570								
		571								

Phase of Flight	Trigger	High Level	ATC / ATIS / AWOS	Radios	First Level/Task Descriptor	Second Level	Third Level	Fourth Level	Notes	# physical steps (8 more notes)	
						verify cabin differential	look at number above cabin Altitude tape on MFD - should be green				
	pilot decides when	600	Listen to ATIS for KMTN - 124.925								
		601		Com1 Active: NY Center Com1 Standby: NY Com2 Monitor: Guard Com2 Standby: Flightwatch	Decide you are close enough to MTN and should be able to pick up ATIS Set up back up radio to ATIS - 124.925						
		602									
		603				Identify which radio is in use select COM 2 radio	press COM knob on PFD		active frequency text is green - COM 1		
		604									
		605						verify blue box is on COM 2 radio			
		606							set 124		
		607				tune in standby using big knob... and little knob			set 925		
		608									
		609		Com1 Active: NY Center Com1 Standby: NY Com2 Monitor: Guard Com2 Standby: MTN/ATIS		activate frequency					
		610									
		611		Com1 Active: NY Center Com1 Standby: NY Com2 Monitor: MTN/ATIS Com2 Standby: Guard			Press <- button	verify that active frequency in COM 2 is 124.925	just checking here - it should still be on from earlier actions above		
		612				verify COM2 light on Audio panel is on					
		613		Martin State Airport Information Hotel 125.3 Zulu automated weather, wind 120 at 13, visibility 3 miles in mist, 800 scattered, 1100 overcast, temperature 19, dew point 17, altimeter 29.90. RNAV approaches are in use. Landing and Departing Runway 15. Notice to airmen, the ILS for runway 33 is out of service. Feedback all runway assignments and all hold short instructions. Birds are on & near the airport. Advise the controller on initial contact you have information Hotel.							
	make this available when aircraft is within 75 miles of Martins State (at MXE)	614				pilot listens					
		615				put destination altimeter setting in back-up altimeter					
		616									
		617			Switch COM2 active frequency back to guard	hit knob on back-up altimeter to 29.90					
		618				press <-					

Phase of Flight	Trigger	High Level	ATC / ATIS / AWOS	Radios	First Level/Task Descriptor	Second Level	Third Level	Fourth Level	Notes	# physical steps (8 more notes)
		645				Leaf through paper charts or select electronic chart			This and all other approach and arrival tasks are concurrent with continued monitoring of the aircraft configuration, altitude, airspeed, heading and autopilot functions. The pilot should spend a maximum of two seconds away from the normal panel scan	
		646				Select chart that matches approach now in flight plan RNAV (GPS) Runway 33				
		647			Note approach control frequency 119.0				so you recognize that when given this frequency, the next one will be lower and you can enter Tower freq. in standby	
		648			brief 2000 ft. to JUGMCO JAF				Display is flightplan on MFD	
		649			brief JUGMCO to CINDI course 336	verify on display				
		650								
		651			brief need to remain at 2000 ft. to CINDI (F4F)	verify on display				
		652								
		653			brief CINDI to MAP course 326	verify on display				
		654								
		655				verify on display				
		656			brief descent to 520 ft. MDA for circling approach				reminder to self that we aren't going to full flaps during approach because you will be circling and don't want the extra drag during turns - need higher approach speed because you are at approach flaps	
		657			brief approach configuration will be approach flaps, gear down and Vref + 20					
		658				set BARO minimum				
		659				press T/IR/REF softkey on PFD				
		660				use big FMS knob on PFD to scroll down to BARO MIN				
		661				Use small FMS knob on PFD to set 520 ft.			sets circling minimum	
		662			brief missed approach is climb to 3000 direct to PLYK and on track 328 degrees to SKLS and hold					
		663				verify on display				
		664			Clip approach and airport diagram to yoke				Display is flightplan on MFD	
		665							RAIM (Receiver Autonomous Integrity Monitoring) is required to ensure sufficient accuracy to perform a GPS Approach. A RAIM check should be performed for all GPS approaches. It is unnecessary for ILS, LOC, and VOR approaches.	
	pilot decides when	666	RAIM Prediction							
		667			Select AUX Chapters	Twist large MFD knob				
		668			Select GPS Status Page	Twist small MFD knob				
		669			Activate Cursor	Press FMS knob on Center Console			Fourth AUX page	
		670							highlights RAIM Prediction	
		671							WARPPOINT field	

Phase of Flight	Trigger	High Level	ATC / ATIS / AWOS	Radios	First Level/Task Descriptor	Second Level	Third Level	Fourth Level	Notes	# physical steps (6 more notes)
	aircraft is descending through 10,000 ft. MSL (existing clouds - between layers)	Adjust aircraft external lights		Com1 Active: Potomac Com1 Standby: MTN Tower Com2 Monitor: Guard Com2 Standby: MTN/ATIS	note you are in VMC conditions in between layers of clouds decide that you want to turn lights on to make yourself more visible to other aircraft who are also between layers	check that ALT is white			next vertical mode that will be active - is automatically in the queue associated with VPTH	
749										
750										
751										
752										
753						flip landing/taxi lights switch on to "landing" position (from off) flip anti-collision lights switch (strobes) to "on" position (from off)			switch has three positions	
754										
755					ATC calls converging traffic to inform them of Citation XXXXX	pilot listens				
756										
757	Aircraft is at ODESA waypoint	Respond to ATC traffic advisory								
758				Com1 Active: Potomac Com1 Standby: MTN Tower Com2 Monitor: Guard Com2 Standby: MTN/ATIS	ATC calls to inform about converging traffic				King Air 350	
759						pilot listens				
760					pilot yells ATC know he/she is in the clouds and can't see traffic					
761						press push to talk			"XXXXX is 1MC"	
762					pilot looks for traffic on display (map 2 Dodge)					
763						pilot twists large FMS knob on MFD to highlight map chapter				
764						pilot twists small FMS knob on MFD to select traffic page (second page)				
765						pilot adjusts range on traffic display to 5 miles (from 20 miles)				
766							twist range knob on center console			
767	Aircraft is descending through 4,000 ft. MSL	Prepare for level off at 3,000 ft.		Com1 Active: Potomac Com1 Standby: MTN Tower Com2 Monitor: Guard Com2 Standby: MTN/ATIS						
768					hear 1000 ft. chime at 4000 ft.					
769						look at altimeter				

Phase of Flight	Trigger	High Level	ATC / ATIS / AWOS	Radios	First Level/Task Descriptor	Second Level	Third Level	Fourth Level	Notes	# physical steps (6 more notes)
					monitor the altitude tape to verify level off 200 ft. above 3,000 note flashing and reverse lighting of altitude preselct number at the top of the altitude tape VPATH disappears on PED	look at airspeed indicator to keep airspeed below 200 Kts	pilot looks at altitude display and points and says "4000 descending 3000)			
					ALT on PFD turns from white to green Note that pitch attitude increases to level Pilot increases power to maintain airspeed	move throttles forward as required			pilot doesn't know that there is a hold coming	
						look at airspeed indicator to keep airspeed below 200 Kts			don't put it in cruise descent because this would put you at too fast a speed - will soon be under brown airspace, limit is 200 Kts	
					verify altitude capture	Pilot notes normal video on PFD altitude selection display verify green ALT mode on PFD				
					monitor pitch change					
					ATC give holding clearance to King Air					
					"King Air 79R you can expect a short delay into Martin State. Advise when ready to copy holding clearance."					
					Com1 Active: Potomac Com2 Standby: MTN Tower Com2 Standby: MTNATS					
					pilot hears that another aircraft going into MTN is being given a holding clearance					
					(King Air advises ready to copy)					
					"King Air 79R is cleared to hold southeast of JUGMO on the 326 degree bearing. Inbound, left hand turns, maintain 2000, expect approach clearance in 20 minutes.					
					Com1 Active: Potomac Com1 Standby: MTN Tower Com2 Monitor: Guard Com2 Standby: MTNATS					
					Pilot notes specific holding clearance given to another aircraft going into MTN					
					(King Air reads back holding clearance)					
					"King Air 79R readback correct"					
					Respond to ATC call about hearing to perform a hold					
					Com1 Active: Potomac Com1 Standby: MTN Tower Com2 Monitor: Guard Com2 Standby: MTNATS					
					ATC calls to inform about the need to hold					
					"Citation XXXXX, you also can expect a short delay into Martin State. Advise when ready to copy holding clearance."					
					pilot gets pen to copy					
						pilot listens				

Phase of Flight	Trigger	High Level	ATC / ATIS / AWOS	Radios	First Level/Task Descriptor	Second Level	Third Level	Fourth Level	Notes	# physical steps (6 more notes)
		819				press the FPL button on center console				
		820				activate cursor				
		821					press FMS knob		JUGMO is in approach twice - once as IAF and once as the missed hold, we want to select the second one	
		822				highlight the JUGMO fix on the hold				
		823				select direct to JUGMO	press direct button on the console			
		824								
		825					press direct button on the console			confirmation box has magenta arrow and may say "activate" now aircraft is headed toward JUGMO (still) but will enter hold automatically when you get there
		826					press direct button on the console			
		827					press FMS knob			
		828					press FMS button on center console			
		829			check airspeed and determine if adjustments are necessary				200 Kts is airspeed limit for flying hold at 3,000 ft WSL (altitudes below 6,000 ft)	
		830				adjust throttle as required				
		831			monitor entrance into hold					
		832			consider that you've been hold to expect approach clearance in 20 minutes and decide you want to check fuel status					
		833				look at fuel indicator on MFD				
		834				realize that you have plenty of fuel (left KTEB with full fuel)				
	pilot crosses JUGMO and begins teardrop entry	835			report entering hold					
		836				pilot presses push to talk button			"XXXXX is entering the hold at JUGMO, 5,000"	
		837								
	pilot reports entering the hold	838	"Claton XXXXX, Roger"	Com1 Active: Potomac Aptch Com1 Standby: MTN Tower Com2 Monitor: Guard Com2 Standby: MTNATIS	ATC acknowledges					
		839			look for traffic 1,000 ft. below	pilot listens				
		840			continue to monitor progress of the hold					
		841	King Air is cleared for the Approach							
		842	King Air 79R maintain 2000 until established. Cleared for the runway 33 R/VAP approach to Martin State, circle runway 15.	Com1 Active: Potomac Aptch Com1 Standby: MTN Tower Com2 Monitor: Guard Com2 Standby: MTNATIS						this should happen as soon as the VA enters the hold so that VA will only make one full turn in hold
	Aircraft crosses JUGMO on teardrop entry into the hold	843	(King Air reads back approach clearance)							
		844	King Air 79R, readback is correct. Contact Martin State tower on 121.3 crossing CINDI-							
		845				hear ATC clear traffic below you for the approach				

Phase of Flight	Trigger	High Level	ATC / ATIS / AWOS	Radios	First Level/Task Descriptor	Second Level	Third Level	Fourth Level	Notes	# physical steps (6 more notes)
		846				consider that you may be released from hold and cleared for the approach soon				
		847			take fleeting glance at paper approach chart clipped to the yoke					
	pilot determines when	848	complete Approach Checklist		remember that you need to do approach checklist and that you like to do approach checklist as read and do and may even need to delay some items					
		849			get checklist from glare shield					
		850			1. pressurization					
		851				look at cabin altitude and see that it is approaching field elevation				
		852				look at differential pressure and see that it is really small				
		853								
		854			2. seats and belts - adjusted and secured	grab shoulder harness and make sure it is still on				
		855				grab the seat belt and make sure still secure				
		856								
		857			3. avionics and flight instruments	check com frequencies	look at approach plate	lower frequency		
		858					compare that with frequency in standby of active radio			
		859								
		860								
		861				do scan of flight director line of PFD to review vertical and nav modes				
		862					confirm that you are in ALT mode and GPS mode		we pressed NAV button but are in GPS mode	
		863			4. minimums	verify that minimums have already been set	look at flight plan page that is displayed on MFD			
		864					minimums displayed			
		865					look at paper chart and make sure what is in flight plan matches what is on the chart			
		866								
		867			5. pax safety switch - set	decide to ignore because n/a				
		868			6. pax seats (upright) - check	decide to ignore because n/a				
		869								
		870								
		871			7. fuel transfer knob - off	look at knob and confirm arrow pointing up			knob is near yoke	
		872								
		873			8. anti-ice/de-ice systems as required					

Phase of Flight	Trigger	High Level	ATC / ATIS / AWOS	Radios	First Level/Task Descriptor	Second Level	Third Level	Fourth Level	Notes	# physical steps (6 more notes)
		900								
		901				Confirm approach is active	Enter			
		902					Look for the magenta arrow on the flight plan to be pointing to the JUGMO IAF			
	pilot decides when	903	Configure aircraft as per Cessna SOP for approach							
		904			Extend flaps to approach	Look at airspeed indicator and verify that you are under 185kts Lower flaps	Place flap lever in approach detent			
		905								
		906								
		907								
		908								
		909								
		910			Recall that flaps remained to be done on approach checklist					
		911			say "approach checklist complete"					
		912			Reduce airspeed below 150kts					
		913				Reduce power as required by pulling back the throttles				
		914			Gear down					
		915				Place gear handle in down position				
		916				Notice red transit light next to gear handle				
		917				Note 3 green lights and no red lights next to gear handle				
		918					Say "3 greens no reds"			
	Aircraft crosses JUGMO	919	Initiate the approach							
		920			Reset altitude to 2000ft	Dial in 2000ft. on altimeter				
		921								
		922								
		923			3000ft Chime					
		924			See altitude flashing		Twist ALT_SEL knob on mode control panel			
		925				Notice and point to altitude on PFD and announce "3000 descending 2000"				
		926			Monitor airspeed and continue to slow to VREF plus 20					
		927				Adjust throttles as necessary				
		928			Set heading bug for circling direction					
		929				Twist heading knob on mode control panel to 010				
	aircraft reaches 2000 ft. MSL	930	Level off at 2000ft.							

Phase of Flight	Trigger	High Level	ATC / ATIS / AWOS	Radios	First Level/Task Descriptor	Second Level	Third Level	Fourth Level	Notes	# physical steps (8 more notes)
					ALT turns green on PFD and VS disappears					
					Maintain airspeed					
						Adjust throttle to maintain VREF +20				
									Break off from RNAV approach and circle no lower than 500' MSL (1.3nm before runway threshold)	
	Pilot sees runway	1001	Perform circle to land maneuver to runway 15	Com1 Active: MTN Tower Com1 Standby: MTN Com2 Monitor: Guard Com2 Standby: MTN/ATIS	Inhale circle to land	Call tower	press push to talk		Starting circle to runway 15"	
		1002								
		1003			Tower replies and repeats clearance to land	Recall heading bug has already been set				
		1004			Pilot acknowledges clearance to land	press push to talk				
		1005	"Roger"							
		1006			Turn toward downwind	Recall heading bug has already been set				
		1007			Pilot acknowledges clearance to land	press HDG button on mode control panel				
		1008				Verify HDG mode on PFD				
		1009								
		1010								
		1011								
		1012								
		1013								
		1014								
		1015			Inhale downwind	Twist HDG knob on mode control panel to 326				
		1016				Note aircraft turning to new heading				
		1017								
		1018			Continue to monitor airspeed					
		1019			Monitor distance from runway					
		1020			At approximately 45 degrees, inhale base leg					
		1021				Twist heading knob on mode control panel to 220				
		1022				Note aircraft turning to new heading				
		1023	aircraft is on base leg of circle to land maneuver	Com1 Active: MTN Tower Com1 Standby: MTN Com2 Monitor: Guard Com2 Standby: MTN/ATIS						
		1024	Initiate descent from MDA		Disconnected autopilot	Press forward on trim buttons on yoke				
		1025								
		1026			Reduce power	Adjust throttles to maintain VREF+20				
		1027			Announce leaving MDA to self	say out loud "leaving MDA"				
		1028								
		1029								
		1030	aircraft is almost aligned with runway 15 center line	Com1 Active: MTN Tower Com1 Standby: MTN Com2 Monitor: Guard Com2 Standby: MTN/ATIS						
		1031	Turn final		Turn to intercept final approach	Turn yoke to left to establish 30 degree bank turn				
		1032								

Phase of Flight	Trigger	High Level	ATC / ATIS / AWOS	Radios	First Level/Task Descriptor	Second Level	Third Level	Fourth Level	Notes	# physical steps (6 more notes)
		1033				Roll out to align with runway 15	Turn yoke to right			
		1034								
	Pilot decides	1035	Configure aircraft per Cessna SOP for landing	Com1 Active: MTN Tower Com1 Standby: MTN Ground Com2 Monitor: Guard Com2 Standby: MTN/ATIS	Configure for landing	Full flaps	Flap lever to landing detent			
		1036								
		1037								
		1038								
		1039				Slow to Vref to Vref +10	Adjust throttles to maintain Vref to Vref +10			
		1040								
		1041			Flow Check	Check flaps	Full flaps			
		1042				Check gear	3 greens, no reds			
		1043				Check speed brakes	Speed brakes retracted			
		1044								
		1045								
		1046								
		1047								
		1048			Maintain VREF					
		1049								
		1050			Disengage yaw damper	Adjust throttles to maintain VREF (on the order of 48% N1)	Press red button on yoke			
		1051					Verify yaw damper is disengaged			
		1052						Check yaw damper indication has disappeared from PFD		
		1053								
		1054	Fly aircraft on Final		Follow VASI	Maintain VREF				
		1055								
		1056				Maintain glide slope				
		1057								
		1058								
		1059								
Landing		1060	aircraft is over runway at 50 ft. AGL	Com1 Active: MTN Tower Com1 Standby: MTN Ground Com2 Monitor: Guard Com2 Standby: MTN/ATIS						
		1061	Land airplane		At 50 AGL throttles idle	Land on main wheats straddling center line				
		1062								
		1063				Lower nose wheel				
		1064								
		1065				deploy speed brakes				
		1066								
		1067				Slow to taxi speed				
		1068								
	aircraft has landed and slowed to taxi speed	1069	Exit runway in accordance with turn-off plan	Com1 Active: MTN Tower Com1 Standby: MTN Ground Com2 Monitor: Guard Com2 Standby: MTN/ATIS		Apply brakes				
		1070								
		1071				Follow leadoff center line				
End Task Analysis		1072	End Task Analysis							
		1073	ATC tells XXXXX to contact Ground				Apply rudders and brakes as necessary			
		1074			Clearance XXXXX contact Ground on 121.8					

Phase of Flight	Trigger	High Level	ATC / ATIS / AWOS	Radios	First Level/Task Descriptor	Second Level	Third Level	Fourth Level	Notes	# physical steps (6+ more notes)
		1075 Switch to Ground frequency.		Com1 Active: MTN Ground Com1 Standby: MTN Tower Com2 Monitor: Guard Com2 Standby: MTN/ATIS						
		1076 Configure aircraft as per Cessna SOP								
		1077 Perform after Landing Checklist								
Taxi In		1078 Obtain taxi clearance from Ground								
		1079								
		1080	<i>Citation XXXXX, where do you park?*</i>	Com1 Active: MTN Ground Com1 Standby: MTN Tower Com2 Monitor: Guard Com2 Standby: MTN/ATIS	Pilot asks to park at transient parking for a short stop.					
		1081								
		1082		Com1 Active: MTN Ground Com1 Standby: MTN Tower Com2 Monitor: Guard Com2 Standby: MTN/ATIS						
		1083 Taxi on taxiways to ramp								
		1084 Monitor SAFE TAXI page on MFD (G100)								
Engine Shutdown		1085								
		1086 Execute engine shutdown per Cessna SOP								
		1087 Perform Shutdown Checklist (except last two items)								

Appendix A-2. Scenarios for Flight Leg 2

Phase of Flight	Trigger	High Level	ATC / Traffic / ATIS / AMOS	Radios	First Level/Risk Descriptor	Second Level	Third Level	Fourth Level	Notes	# physical steps (8 more notes)	
Preflight Preparation at Aircraft		1	Battery - CONNECT (deferred)	Com1 Active: MTN Ground Com1 Standby: MTN Tower Com2 Monitor: Guard Com2 Standby: MTN ATIS							
		2	Cockpit Preparation (Cockpit set-up flow) - COMPLETE								
		3	Cockpit Set-up Checklist - COMPLETE								
		4	Lights - ON (deferred)								
		5	Fltcl Heat - ON (for 20 seconds, then OFF (deferred)								
		6	Lights and Hot Items - Check (deferred)								
		7	Lights Off (deferred)								
		8	External Pre-flight - PERF O/KM (deferred)								
		9	GPU - CONNECT								
		10	Battery - ON								
		11	Avionics Power - ON								
		12	G1000 Initialization								
		13	PTD Alert messages - check and resolve (G1000)								
		14	Fuel Weight and Performance Entries - COMPLETE							Nav 1 set on US frequency back onto TIB. Nav 2 set on TIB OR. DME box set to Nav 2. And DME box is displayed on PFD	
		15	Takeoff Data - Set and ON								
		16									
		17	Copy ATIS - 124.925: Pilot switches to ATIS frequency	Com1 Back-up: MTN Ground Com1 Standby: MTN Tower Com2 Monitor: MTN ATIS Com2 Standby: Guard							

Phase of Flight	Trigger	High Level	ATC / Traffic / ATIS / AMOS	Radios	First Level/Risk Descriptor	Second Level	Third Level	Fourth Level	Notes	# physical steps (8 more notes)
		32 Review enroute chart								
		33 Review destination airport charts							This isn't an approach brief, it's just a check to ensure they are all available	
		34 Complete Preflight Checklist								
Engine Start		35 Complete Before Start Checklist								
		36 Monitor engine parameters per Cessna SOP (G1000)								
		37 Complete After Start SOP								
		38 PFD Alert messages - check and resolve (G1000)								
Taxi Out		39 Configure aircraft per Cessna SOP								
		40 Confirm avionics set up - SAFE TAXI (G1000)								
		41 Confirm take off data (G1000)								
		42 CAS messages - check & resolve (G1000)								
		43 Complete Before Taxi Checklist								
		44 Request ATC taxi clearance - 121.8								
		45 Read back taxi clearance								
		46 Confirm Taxi Routing on MFD (G1000)								
		47 Accomplish Brake and Flight Control Check								
		48 Taxi Out								
		49 Change to Tower Frequency 121.30								
		50 Enter departure frequency in Com 1 standby								
		51 Complete Before Takeoff Checklist down to the line								
		52 Select desired dimm mode (FD, HDG & ALT engaged, G1000)								
		53 Engage flight guidance and navigation modes as necessary (G1000)								
Takeoff		54 Obtain ATC takeoff clearance - 121.3								
	Pilot lets ATC know they are ready for Takeoff	55 Finish the Before Takeoff Checklist (items below the line)								
		56 All Lights ON								
		57 Windshield Heat ON								
		58 Pilot Heat ON								
		59 Taxi into position and wait on runway								
BEGIN TASK ANALYSIS		60 <i>Begin Task Analysis</i>								
	aircraft in position and holding on runway 15, KMTN	61 Receive takeoff clearance and take off								

Phase of Flight	Trigger	High Level	ATC / Traffic / ATIS / AMOS	Radios	First Level/Risk Descriptor	Second Level	Third Level	Fourth Level	Notes	# physical steps (8 more notes)
		67	Citation XXXXX wind is 120 at 8, maintain runway heading climb and maintain 2000 runway 15. clear for takeoff "	Com1 Active: MTN Tower Com1 Standby: Polomac Dep 1 Com2 Monitor: Guard Com2 Standby: MTN/ATIS	ATC clears pilot to take off	Listen to ATC clearance				
		68			Read back clearance					
		69								
		70								
		71			Hot items on	press push to talk				
		72				windshields on				
		73				pilot static on				
		74			Lights					
		75			Half throttle	Pax safety, landing and anti-coll lights as required				
		76			Half throttle					
		77			Full throttle	Verify equal power				
		78								
		79				Verify both engines T/O on takeoff mode annunciator on MFD				
		80				Verify both engines full power			T/O = full power	
		81			Release brakes				up to the blue bug	
		82			Hold center line with Rudder					
		83			Verify airspeed is alive				last from time you release brakes to V1	
		84			Check temperatures and pressures					
		85			Monitor engine sound and cockpit lights and noises					
		86				visual monitor			concurrent	
		87				auditory monitor			After 80kts takeoff would occur unless engine fire or failure, master warning, loss of pilot, or loss of control	
		88							V1=VR	
		89			Look for 80k					
		90			Look for 80k	hand off the throttle and onto yoke				
		91	aircraft reaches VR speed	Rotation at V _R						
		92		Com1 Active: MTN Tower Com1 Standby: Polomac Dep 1 Com2 Monitor: Guard Com2 Standby: MTN/ATIS	Pitch to command bar					
		93			monitor climb	Pull back on yoke				
		94				Maintain wings level				
		95				Monitor for positive rate of climb				
		96								
		97								
		98	pilot confirms Positive Rate of Climb	Retract gear and flaps per Cassra SOP						
		99		Com1 Active: MTN Tower Com1 Standby: Polomac Dep 1 Com2 Monitor: Guard Com2 Standby: MTN/ATIS	Gear handle up					
		100				Listen for gear retraction				
		101			Verify V2	Verify transit light extinguished				
		102			Clear of obstacles				concurrent task	
		103			Flap handle up					
		104			Verify Verr				Look at flap indicator on MFD	
		105			Continue acceleration				Verr = 118	
		106								
		107								
		108								
		109								
		110							Verify FLC mode on PFD	

Phase of Flight	Trigger	High Level	ATC / Traffic / ATIS / AMOS	Radios	First Level/Risk Descriptor	Second Level	Third Level	Fourth Level	Notes	# physical steps (if more notes)
		111				Select 170Kts				
		112	(Aircraft enters scattered clouds at 800 ft)							
		113	Respond to Tower hand off to Departure controller	Com1 Active: MTN Tower Com1 Standby: Potomac Dep 1 Com2 Monitor: Guard Com2 Standby: MTN/ATIS						
	Aircraft is at 800 ft. MSL	114								
		115	*Citation XXXXX contact Potomac Departure on 119.0.		ATC gives frequency change	pilot listens				
		116			Pilot acknowledges instruction to contact departure					presses push to talk switch
		117								
		118			members frequency has already been entered into standby for COM 1	press push to talk				
		119								freq = 119.0
		120								
		121		Com1 Active: Potomac Dep 1 Com1 Standby: MTN Tower Com2 Monitor: Guard Com2 Standby: MTN/ATIS		Verify frequency just given is in standby for COM 1 press <-> button				
		122	Contact Potomac Departure Control							check that the active frequency is now 119.0
	pilot decides when	123			pilot contacts Potomac Departure					
		124								pilot says "potomac departure, Citation XXXX, xxxx (alt.) climbing 2000"
		125		Com1 Active: Potomac Dep 1 Com1 Standby: MTN Tower Com2 Monitor: Guard Com2 Standby: MTN/ATIS	ATC acknowledges contact and gives radar vectors					
	Pilot checks in with Departure Controller	126	*Potomac Departure, XXXXX radar contact XXXX ft. (alt.) Turn heading 190, maintain 2000 ft.							pilot listens
		127			pilot acknowledges assigned heading and altitude	pilot listens				
		128								"turn heading 190, maintain 2000, XXXXX"
		129	Turn to heading 190							
	pilot decides when	130			Set heading bug					
		131								
		132			Twist HDG knob on mode control panel and verify 190					
		133			Confirm HDG mode on PFD					
		134			Note airplane banking and turning to new heading					
	pilot decides when	135			Engage autoflight as necessary (G1000)					
		136			Press AP button on autopilot					
		137		Com1 Active: Potomac Dep 1 Com1 Standby: MTN Tower Com2 Monitor: Guard Com2 Standby: MTN/ATIS		Verify AP mode on PFD				

Phase of Flight	Trigger	High Level	ATC / Traffic / ATIS / AMOS	Radios	First Level/Task Descriptor	Second Level	Third Level	Fourth Level	Notes	# physical steps (8 more notes)
	pilot decides when	138 Perform takeoff flow check			Set climb power	Reduce throttle to climb detent				
		139								
		140								
		141			Verify flaps up	Check flap handle position up	Verify green CLM on PFD			
		142								
		143			Check pressurization	Verify pressure differential on MFD	Verify flaps up on MFD			
		144			Verify gear up	Check gear handle position up				
		145			Turn strobes off	Flip anticollision switch down				
		146			Turn landing/taxi lights off	Flip landing/taxi lights down to off position				
		147			Check hot items on heat	Check left/right windshield heat				
		148								
		149								
		150								
		151								
		152								
		153								
		154								
		155								
		156								
		157		Com1 Active: Potomac Dep 1 Com1 Standby: MTN Tower Com2 Monitor: Guard Com2 Standby: MTN ATIS	remember need to complete the TO xist get the Xist card out	Check pitotstatic heat on			Concurrent task that will be done while climbing to 2000ft. Will be completed after 2000ft level	completing procedures & make sure the A/C is set up as it should be
	pilot decides when	158								
		159			1. Landing gear	up, done				reading from card & checking on the panel
		160			2. Flaps	up, done				
		161			3. Thrustle	Power set				
		162			4. Yaw damper	On, done				
		163			5. Anti ice systems	not required, pilot considers RAT				this step is performed as a read-and-do, not considered leader as part of the flow
		164			6. PAX safety switch	Off, done				
		165			7. Landing lights	Off, done				turned off when entered clouds
		166			8. Pressurization	checked, done				this step is performed as a read-and-think about, not considered earlier as part of the flow
		167			9. Altimeters	say to self - it is set for lower altitude levels know that you've planned this flight to go above FL180 know that you will have to reset this later				
		168								
		169								
		170								
		171								
		172								
		173								
		174								
		175								
		176								
		177								
		178								
		179								
		180								
		181								

Phase of Flight	Trigger	High Level	ATC / Traffic / ATIS / AWOS	Radios	First Level/Risk Descriptor	Second Level	Third Level	Fourth Level	Notes	# physical steps (8 more notes)
	aircraft is at 1,000 ft. MSL	182 Monitor climb to 2000MSL		Com1 Active: Potomac Dep 1 Com1 Standby: MTN Tower Com2 Standby: MTN ATIS	Hear altitude alert chime at 1000ft	look at altimeter	Pilot points at altimeter and says "1000 climbing 2000"		not an action but they will listen for this or be aware of it	
		183								
		184								
		185								
		186			At 1800 altitude flashes on PFD	Pilot notes flashing reverse video on altitude display				
		187			ALT turns green on PFD	pilot notes that altitude turns green on altitude display				
		188								
		189								
		190			Reduce power	Adjust throttles to maintain less than 200kts				
		191								
		192			verify altitude capture	verify green ALT mode on PFD			you are allowed to continue to accelerate in cruise using climb power for 30 minutes - need to keep track of time	
		193								
		194			monitor pitch change					
		195			note the time					
	aircraft reaches 2,000 ft. MSL	196 respond to amendment to clearance								
		197	"Citation XXXXX, cleared direct PALEO then as filed. Maintain 2000 ft."	Com1 Active: Potomac Dep 1 Com1 Standby: MTN Tower Com2 Monitor: Guard Com2 Standby: MTN ATIS	ATC gives clearance	Pilot listens and remembers			Says "Direct PALEO as filed maintain 2000, XXXXX"	
		198								
		199			Pilot reads back clearance to ATC					
		200				presses push to talk				
		201			Initiate direct PALEO	Press direct button on center console				
		202				Confirmation window - "Activate direct PALEO?"				
		203				Confirm direct PALEO				
		204								
		205								
		206								
	2 nm before aircraft reaches PALEO	207 respond to amendment to clearance								
		208	"Citation XXXXX, cleared direct Nottingham (OTT). Maintain 2000 ft."	Com1 Active: Potomac Dep 1 Com1 Standby: MTN Tower Com2 Monitor: Guard Com2 Standby: MTN ATIS	ATC give clearance	Pilot listens and remembers				
		209								
		210			Pilot reads back clearance to ATC					
		211							Says "Direct OTT, maintain 2000, XXXXX"	
		212			Pilot thinks about task	press push to talk				
		213				realizes that one task is continuation of current state (maintaining current altitude of 2000 ft.) so really only has one task to perform (direct to OTT)				

Phase of Flight	Trigger	High Level	ATC / Traffic / ATIS / AWOS	Radios	First Level/Risk Descriptor	Second Level	Third Level	Fourth Level	Notes	# physical steps (8+ more notes)
		251			turns in standby COM 1 using big knob... and little knob					4 G1000 steps = easy = ID active radio, twist L-COM knob to 124 & S-COM knob to 55, press <-
		252		Com1 Active: Potomac Dep 1 Standby: Potomac Dep 2 Com2 Monitor: Guard Com2 Standby: MTN/ATIS						
		253		Com1 Active: Potomac Dep 1 Standby: Potomac Dep 2 Com2 Monitor: Guard Com2 Standby: MTN/ATIS	activate frequency	press <-> button				
		254		Com1 Active: Potomac Dep 2 Com1 Standby: Potomac Dep 1 Com2 Monitor: Guard Com2 Standby: MTN/ATIS	Pilot Contacts Potomac Departure		check that the active frequency is now 124.55			includes push to talk
		255								
		256								
		257								
	Pilot checks in with new departure controller	258	Roger XXXXX, Good morning		ATC Acknowledges	pilot listens				
		259								
	Aircraft is at 7,000 ft. MSL	260		Com1 Active: Potomac Dep 2 Com1 Standby: Potomac Dep 1 Com2 Monitor: Guard Com2 Standby: MTN/ATIS	respond immediately to ATC instruction to descend				Emergency aircraft is at 10,000 ft.	
		261	Citation XXXXX, descend immediately, maintain 6,000 for emergency traffic.		ATC gives pilot immediate descent instruction	pilot listens				
		262								
		263			Recall that there is an emergency descent procedure				5 step memory item	
		264			Realize that emergency descent procedure must be modified to adapt to the circumstance					
		265			Disengage autopilot				1st memory item AP/trim button (takes you out of autopilot and new mode [horizontal and vertical])	
		266				Press red button on yoke				
		267			Power reduction to idle					
		268				Pull throttles to idle detent				
		269			Decide not to put speed brakes out				2nd memory item 1st modification (3rd memory item) (because you are already climbing at a relatively low altitude and only descending to 6000, call happens at 7000 so you make the action before 7500)	
		270			Decide not to put gear down				2nd modification (4th memory item) (because you are already descending to 6000, call happens at 7000 so you make the action before 7500)	
		271			Pitch 10 degrees nose down				3rd modification (5th memory item) (Only 10 rather than checklist 20 degrees, because not that far to go)	
		272				Push forward on yoke				
		273			Monitor pitch until 10 degrees nose down on PFD					
		274			Call ATC					
		275				Push to talk				
		276			Enter 6000ft as target altitude				Pilot says "Maintaining XXXXX descending immediately to 6000"	

Phase of Flight	Trigger	High Level	ATC / Traffic / ATIS / AWOS	Radios	First Level/Risk Descriptor	Second Level	Third Level	Fourth Level	Notes	# physical steps (if more notes)
		277			Re-engage autopilot	Twist ALT knob on autopilot panel				
		278			Press AP button on autopilot panel					
		279			Activate NAV mode	Press NAV button on autopilot panel			subject pilots might already have NAV mode engaged and not need to activate it here	
		280			Activate VS mode	Press VS button on autopilot panel				
		281			Establish descent airspeed	Bring throttle up to normal descent power setting 220 indicated			Flashing back and forth between normal and reverse video presentation. End of flashing; reverse video blue background black letters	
		282			lock at altimeter	verify (audibly) "7,000" descending 6,000" while pointing			Flashing back and forth between reverse and normal video presentation. End of flashing; reverse video black background blue letters (normal video) when you are at proper altitude	
		283			monitor the altitude tape to verify level off					
		284			200 ft. above 6,000 note flashing and reverse lighting of altitude preset number at the top of the altitude tape					
		285			ALT on PFD turns from white to green					
		286			Note that pitch attitude increases to level					
		287			Bring power back up to normal cruise	move throttles initially to cruise detent and then as required			CODA note - Pilot will keep monitoring	
		288			Verify altitude capture	Pilot notes normal video on PFD altitude selection			CODA note - Pilot will keep monitoring	
		289			monitor the altitude tape to verify level off	verify green ALT mode on PFD			you are allowed to continue to expedite the procedure using climb power for 10 minutes - need to keep track of time	
		290			200 ft. above 6,000 note flashing and reverse lighting of altitude preset number at the top of the altitude tape					
		291			ALT on PFD turns from white to green					
		292			Note that pitch attitude increases to level					
		293			Bring power back up to normal cruise	move throttles initially to cruise detent and then as required			CODA note - Pilot will keep monitoring	
		294			Verify altitude capture	Pilot notes normal video on PFD altitude selection			CODA note - Pilot will keep monitoring	
		295			monitor pitch change	verify green ALT mode on PFD			you are allowed to continue to expedite the procedure using climb power for 10 minutes - need to keep track of time	
		296			note the time					
		297								
		298								
		299								
		300								
		301								
	Aircraft is 5 DME before OTT	302								
		303								
		304								
		305								

Phase of Flight	Trigger	High Level	ATC / Traffic / ATIS / AMOS	Radios	First Level/Task Descriptor	Second Level	Third Level	Fourth Level	Notes	# physical steps (8 more notes)
		306				press push to talk			Says "Resume climb 12,000", 119.7, XXXXX"	
		307			Pilot thinks about task - two parts					
		308			pilot decides to resume climb to 12,000 fmsl					
		309			initiate climb					
		310				Set climb power				
		311					Set throttles to CLM detent			
		312					Verify CLM green on power tape on the MFD			
		313				Press ALT button on mode control panel				
		314				Verify pitch mode on PFD				
		315				Set 10 degrees nose up pitch				
		316					Turn pitch wheel on mode control panel			
		317				Verify vertical speed				
		318			Pilot remembers second task - to contact Potomac departure					
		319			remembers frequency				freq = 119.7	
		320			identify which radio is in use				active frequency/text is green (blue box around standby freq)	if you want to tune the other radio, press the COM knob once
		321			tune in standby COM 1 using big knob... .. and little knob					if 61000 steps = easy = ID active radio, twist COM knob to 119 & 5-COM knob to 7, press <-
		322								
		323								
		324				press <-> button				
		325								
		326								
		327				press push to talk				
		328							pilot says "potomac departure. Citation XXXXX, xxx(ALT) climbing 12000 direct OTT."	
		329			"XXXXX, Roger"					
		330								
		331								
		332								
		333								
		334								
		335								
		336								

Phase of Flight	Trigger	High Level	ATC / Traffic / ATIS / AMOS	Radios	First Level/Risk Descriptor	Second Level	Third Level	Fourth Level	Notes	# physical steps (8 more notes)
		392			monitor pitch change					
		393			note the time				you are allowed to continue to accelerate in cruise using climb power for 10 minutes - need to keep track of time	
Cruise		394		Com1 Active: Wash Center 1 Com1 Standby: Polonac Dep 3 Com2 Monitor: Guard Com2 Standby: MTN/ATIS						
	pilot decides when	395			complete Cruise cockpit flow					
		396			remember that cruise flow actions need to be performed					
		397			After 10 (or fewer) minutes have passed, reduce power				need to be careful that you don't overspeed - may need to reduce to cruise power or lower before 10 mins have passed	These next 3 steps are part of cockpit cruise flow
		398			move throttle to appropriate setting (cruise detent or lower) to desired speed					
		399			think about anti-ice systems	Verify need to leave anti-ice systems on				
		400								
		401					Look at RAT on PFD			
		402						note in visible moisture and less than 10 degrees Celsius		
		403			Check pressurization	verify cabin altitude				
		404								
		405				verify cabin differential	look at tape on MFD - triangle should be pointing within green section			
		406					look at number above cabin Altitude tape on MFD - should be green			
		407								
		408		Com1 Active: Wash Center 1 Com1 Standby: Polonac Dep 3 Com2 Monitor: Guard Com2 Standby: MTN/ATIS	remember that cruise checklist needs to be completed					
	pilot decides when	409			retrieve checklist from glareshield					
		410			1. throttles					
		411			2. anti-ice/de-ice	verify in cruise detent or as desired				
		413			3. pressurization	remember on				
		414								
		415								
		416				verify check was complete				
		417								
		418			4. In RVSM airspace	realize N/A				
		419			Set destination field elevation					
		420				Press TMR/REF sorkey on PFD				
		421					Turn large FMS knob on PFD to highlight destination field elevation			
		422					Turn small FMS knob on PFD to set destination field elevation to 3900ft			

Phase of Flight	Trigger	High Level	ATC / Traffic / ATIS / AMOS	Radios	First Level/Task Descriptor	Second Level	Third Level	Fourth Level	Notes	# physical steps (8 more notes)
		423			Note that checklist is complete					
		424			put checklist card away back on glareshield					
		425			Think about "what is next to be done?"					
		426		Com1 Active: Wash Center Com1 Standby: Polomac Com2 Monitor: Guard Com2 Standby: MTN ATIS	Retrieve METAR and TAF via XM data link (G1000)					
	pilot decides when	427			Select waypoints on MFD					
		428				turn large FMS knob on center console to highlight waypoint chapter				
		429				see waypoint chapter highlighted on MFD				
		430			turn small FMS knob to highlight airport page					
		431				see far left page in Waypoint chapter get highlighted				
		432								
		433				press WX softkey on MFD				
		434				read METAR section of waypoint page				
		435				evaluate weather and winds				
		436				compare winds to runway				
		437				note that the winds favor runway 25				
		438								
		439				note that you have a crosswind				
		440				note that METAR says you have mist and that runway is likely to be wet				
		441								
		442				note ILS to runway 25				
		443				Plan on ILS to runway 25				
		444				Compare visibility to approach requirement				
		445				Note visibility is greater than the required 1 mile				
		446				Compare ceiling to approach minimums				
		447				Note 1000ft is greater than the 300ft required				
		448				Note temperature dew point spread				
		449				Note spread is greater than 4 degrees therefore little chance of fog forming				
		450				note that runway should be dry				
		451								
	pilot decides when	452								
		453								

Phase of Flight	Trigger	High Level	ATC / Traffic / ATIS / AWOS	Radios	First Level/Risk Descriptor	Second Level	Third Level	Fourth Level	Notes	# physical steps (8 more notes)
		454			Set frequency	Flip through weather package to find frequency				
		455			Make COM 2 the active radio				134.725 in M and PA, 134.525 in Maryland and Virginia	
		456				Press the COM1 knob on PFD				
		457								
		458								
		459								
		460				turn in standby using big knob... and little knob				4 G1000 steps = easy = ID active radio, twist COM knob to 134 & S-COM knob to 525, press <->
		461		Com1 Active: Wash Center 1 Com1 Standby: Polomac Dep 3 Com2 Monitor: Guard Com2 Standby: Flight Watch		activate frequency				
		462		Com1 Active: Wash Center 1 Com1 Standby: Polomac Dep 3 Com2 Monitor: Flight Watch Com2 Standby: Guard			press <-> button			
		463		Com1 Active: Wash Center 1 Com1 Standby: Polomac Dep 3 Com2 Monitor: Flight Watch Com2 Standby: Guard				check that the active frequency is now 134.525 in COM 2		
		464			Call ATC and ask to leave current frequency				"Washington Center, XXXXX request base frequency for weather update"	
		465				press push to talk				
		466		Com1 Active: Wash Center 1 Com1 Standby: Polomac Dep 3 Com2 Monitor: Flight Watch Com2 Standby: Guard	ATC clears pilot off frequency					
	Pilots asks to go off frequency (pilots before 10 nm before CSN)	467	"XXXXX report back on no later than 10 nm before CSN, frequency change to flight watch approved"	Com1 Active: Wash Center 1 Com1 Standby: Polomac Dep 3 Com2 Monitor: Flight Watch Com2 Standby: Guard					see TA steps below beginning line 633 related to responding to this Clearance for descent to 15,000	
	Alternate clearance if pilots within 15 nm of CSN when calls to ask for permission to go off frequency	468				pilot listens				
		469			Respond to ATC					
		470			Switch to COM 2	press push to talk			"XXXX leaving frequency"	
		471				Press COM 2 MIC button on audio panel				
		472								
		473		Com1 Back-up: Wash Center 1 Com1 Standby: Polomac Dep 3 Com2 Active: Flight Watch Com2 Standby: Guard						
		474			Make contact with Flightwatch					
		475				press push to talk			Flightwatch: Citation XXXXX (flight level 200 (location)) request weather update for HSP"	
		476		Com1 Back-up: Wash Center 1 Com1 Standby: Polomac Dep 3 Com2 Active: Flight Watch Com2 Standby: Guard	Flightwatch asks pilot question					
	After Pilot asks for WX update from Flight Watch	477	"XXXXX Flightwatch say time of arrival at Hot Springs		Respond to Flightwatch question	Pilot listens				
		478								
		479			Respond to Flightwatch question	Compute arrival time				

Phase of Flight	Trigger	High Level	ATC / Traffic / ATIS / AMOS	Radios	First Level/Task Descriptor	Second Level	Third Level	Fourth Level	Notes	# physical steps (if more notes)
		510		Com1 Back-up: Wash Com1 Standby: Polomac Com2 Standby: Guard		press push to talk			"XXXX, winds XXXX, RAM air temperature XX, IMC, negative turbulence, XXXXX is a CE-510"	
	Pilot finishes giving PIREP	511	"XXXXX thank you very much"	Com1 Active: Flight Watch Com2 Standby: Guard	Flightwatch thanks pilot for PIREP	pilot listens				
		512			Remember to return 121.5 to active frequency on COM 2 Press <-> button					
		513								
		514		Com1 Back-up: Wash Com1 Standby: Polomac Dep 3 Com2 Active: Guard Com2 Standby: Flight Watch						
		515								
		516			Report back on frequency with Washington Center					
		517			Activate COM 1					
		518				Press COM 1 MIC button on audio panel				
		519		Com1 Active: Wash Center Com1 Standby: Polomac Dep 3 Com2 Monitor: Guard Com2 Standby: Flight Watch			Verify that COM 1 is now active (displayed in green)			
		520			Report back on					
		521				press push to talk				
		522		Com1 Active: Wash Center Com1 Standby: Polomac Dep 3 Com2 Monitor: Guard Com2 Standby: Flight Watch	ATC acknowledges Pilot radio call	pilot listens				
	Pilot reports back on frequency	523	"XXXXX Roger"							
		524			Evaluate weather and winds					
		525				Compare winds to runway				
		526				Compare winds to runway	Note that the winds favor runway 25			
		527				Pull out approach plates and airport diagram				
		528				Compare visibility to approach requirement	Note ILS to runway 25			
		529				Compare ceiling to approach minimums	Plan on ILS to runway 25			
		530				Compare temperature dew point spread	Note visibility is greater than the required 1 mile			
		531				Compare ceiling to approach minimums	Note 1000ft is greater than the 300ft required			
		532				Compare temperature dew point spread	Note spread is greater than 4 degrees therefore little chance of fog forming			
		533								
		534								
		535								
		536								
		537			Clip approach plate and airport diagram to yoke	Note that runway should be dry				

Phase of Flight	Trigger	High Level	ATC / Traffic / ATIS / AMOS	Radios	First Level/Risk Descriptor	Second Level	Third Level	Fourth Level	Notes	# physical steps (8 more notes)
	pilot decides when									
		538	Prepare for arrival and ILS approach to runway 25 at KHSP, Select and Load into G1000	Com1 Active: Wash Center Com1 Standby: Polonac Dep 3 Com2 Monitor: Guard Com2 Standby: Flight Watch	Select landing runway					
		539								
		540								
		541			Select available arrivals					
		542				Press AFR softkey on MFD				
		543								
		544			Evaluate available approaches					
		545				Press AFR softkey on MFD				
		546				Press FMS knob on center console				
		547				twist large FMS knob on center console to preview approaches				
		548								
		549								
		550								
		551			Select approach					
		552								
		553			Load approach					
		554								
		555				press Load AFR softkey on MFD				
		556				select IAF				
		557				twist large FMS knob on center console to highlight IFAVU				
		558			Take opportunity of time available now to do mini approach brief					
		559				press ENTER key on center console				
		560								
		561			Setup COM 2 radio to AMOS - 118.8					
		562								
		563				identify which radio is in use				
		564				select COM 2				
		565								
		566				press COM knob on PED				
		567								
		568				twist large FMS knob on center console to preview approaches				
		569								
		570								
		571								
		572								
		573								
		574								
		575								
		576								
		577								
		578								
		579								
		580								
		581								
		582								
		583								
		584								
		585								
		586								
		587								
		588								

Phase of Flight	Trigger	High Level	ATC / Traffic / ATIS / AMOS	Radios	First Level/Risk Descriptor	Second Level	Third Level	Fourth Level	Notes	# physical steps (8 more notes)
		569		Com1 Active: Wash Center Com1 Standby: Polomac Dep 3 Com2 Monitor: HSP AMOS Com2 Standby: Guard						
		570				select COM 1 again	press COM knob			
		571								
	Pilot decides when	572	Tune and Listen to AMOS for KHSP – 118.8		Realize 100 miles out from destination and will be able to hear AMOS					
		573								
		574	Trigalls Field Airport Automated Weather Observation, XXXX Zulu Weather, wind 220 at 5, visibility 6 miles, 300 overcast, temperature 11 degrees Celsius, dew point 7, altimeter 29.84."	Com1 Active: Wash Center Com1 Standby: Polomac Dep 3 Com2 Monitor: HSP AMOS Com2 Standby: Guard	AMOS at HSP is heard over the radio	Pilot listens and writes down AMOS info.			air traffic control (ATIS) will have to read time from beginning of scenario to get correct time (one minute weather)	
	make this available when aircraft is 100 miles from Hot Springs (after aircraft passes Cassanova (CSN) VOR)	575								
		576			put destination altimeter setting in back-up altimeter.					
		577				twist knob on back-up altimeter to 29.84				
		578			Return 121.5 to COM 2 active frequency	Press COM button on PFD				
		579								
		580								
		581				Press <-> button	Verify blue box is on COM 2			
		582		Com1 Active: Wash Center Com1 Standby: Polomac Dep 3 Com2 Monitor: Guard Com2 Standby: HSP AMOS			Verify 121.5 is active on COM 2			
		583			Activate COM 1	Press COM button on PFD				
		584								
		585					Verify blue box is on COM 1			
		586			Realize that intended ILS RWY 25 approach should work out given the current winds					
		587								
		588	Brief approach to runway 25 at KHSP							
	Pilot decides when	589			Note approach control (Washington Center) frequency 134.4				so you recognize that when given this frequency, the next one will be CTAF and you can enter CTAF freq. in standby	
		590			Set VNAV profile	Note that approach begins from MQL				
		591				Note altitude at MQL is 8000ft				
		592				Activate flight plan				
		593				Activate flight plan	Press FPL on center console			
		594					Press FMS knob on Center Console			
		595								
		596								
		597								
		598								
		599				Set 8000ft	Turn large FMS knob to highlight altitude field for MQL.			

Phase of Flight	Trigger	High Level	ATC / Traffic / ATIS / AMOS	Radios	First Level/Task Descriptor	Second Level	Third Level	Fourth Level	Notes	# physical steps (8 more notes)
		600					Use keyboard to type in numbers			
		601				Deactivate cursor	Press Enter			
		602					press FMS button on center console			
		603								
		604			brief from approach plate 8000 to IAF IFAVU					
		605			brief 6000 ft. or above to AHLER INT	Verify on display				
		606			AHLER INT	Verify on display				
		607			Brief: final approach fix DURAN at 5100	Verify on display				
		608				Verify on display				
		609			Course 247 inbound from AHLER					
		610				Verify on display				
		611				Verify on display				
		612			brief descent to 4088 decision altitude, one mile visibility					
		613			Set DA (decision altitude)	highlight MAP altitude				
		614				Enter 4088	Turn large FMS knob			
		615					Use keyboard to type in numbers			
		616								
		617				Activate cursor	Press Enter			
		618				Deactivate cursor	press FMS button on center console			
		619								
		620								
		621								
		622				Verify DA entered correctly			Number will be 4090	
		623			brief: need to remain at or above 5100 until pick up glide slope, which is unusable below 4090					
		624			brief: approach configuration will be full flaps, gear down and Vref					
		625			set BARO minimum	press TMR/REF softkey on PFD				
		626				use big FMS knob on PFD to scroll down to BARO MIN				
		627								
		628			brief: missed approach is runway heading to 4400 ft., climb right turn to 6000 via RNL VOR 097 radial, then to NATTS INT and hold					
		629				Verify NATTS intersection, 6000 on display				
		630				Define NATTS intersection				
		631				Enter 116.6 in NAV 1 standby			Row defaults to NAV 1 when plane starts, is from RAINBLE	
		632				Press NAV button on PFD			ROWNAKE	
		633				Enter 109.4 in NAV 2				
		634								
		635				Enter inbound course missed in the hold is 183				

Phase of Flight	Trigger	High Level	ATC / Traffic / ATIS / AWOS	Radios	First Level/Risk Descriptor	Second Level	Third Level	Fourth Level	Notes	# physical steps (8 more notes)
	Aircraft is 10nm before CSN (pilot only gets this if he/she was not given this clearance earlier before bit frequency to call (Flightwatch))	639 respond to ATC instruction		Com1 Active: Wash Center 1 Com1 Standby: Polomac Dep 3 Com2 Monitor: Guard Com2 Standby: HSP AWOS	Self-brief the need for vigilance as there may be others operating at the airport without radar coverage. Also remind self of terrain surrounding the airport. Clip approach and airport diagram to yoke					
Descent		637			Clip approach and airport diagram to yoke					
		638								
		640	*Citation XXXXX For traffic descend and maintain 16,000 Culpeper altimeter 29.86 "	Com1 Active: Wash Center 1 Com1 Standby: Polomac Dep 3 Com2 Monitor: Guard Com2 Standby: HSP AWOS	ATC gives clearance for intermediate descent					
		641			acknowledge clearance	listen to clearance				
		642				press push to talk			"Descend and maintain 16,000, 29.86, XXXXX"	
		643								
		644								
		645			Notes there are 2 pieces to the clearance decide to set up descent first					
		646			Set 16000 in altitude alert box	Turn altitude knob on flight director panel				
		647			Begin descent	Press VS on flight director panel				
		648				Verify VS is green on command bar and ALT is white on PFD command line				
		649								
		650								
		651								
		652			Move whizz wheel to set 2000 ft minute descent					
		653			note aircraft nose is pitched down					
		654			Reduce throttles for descent					
		655			Monitor airspeed				airspeed under redline	
		656			Note that altimeter setting given by ATC is different than AWOS				AWOS = 29.84	
		657			Set 29.86 in standby altimeter	review AWOS notes taken earlier				
		658								
		659				Turn knob on standby altimeter				
		660			Com1 Active: Wash Center 1 Com1 Standby: Polomac Dep 3 Com2 Monitor: Guard Com2 Standby: HSP AWOS					
	pilot decides when	661			Reduce Throttles as required					
		662			Remember that you have Airport AWOS					
		663			Remember that approach is entered in flight plan and that approach is briefed					

Phase of Flight	Trigger	High Level	ATC / Traffic / ATIS / AMOS	Radios	First Level/Risk Descriptor	Second Level	Third Level	Fourth Level	Notes	# physical steps (8 more notes)
		664			Set landing bugs	go to AUX page on MFD				
		665								
		666					turn large FMS knob on center console to AUX chapter			
		667					use small FMS knob to select far left page (first page)			
		668				press FOB SYNC softkey on MFD				
		669				Note landing weight				
		670				retrieve checklist from glareshield				
		671				determine Vap and Vref from the table on the checklist				
		672				activate TMIRREF function				
		673				press TMIRREF softkey on PFD				
		674				highlight Vap				
		675				twist large FMS knob on PFD				
		676				set Vap				
		677				twist small FMS knob to enter 102				
		678				highlight Vref				
		679				twist large FMS knob on PFD to select VREF				
		680				set Vref				
		681				twist small FMS knob to enter 102				
		682				activate landing bugs				
		683								
		684				press PFD menu button				
		685				Select landing references on				
		686				turn large FMS knob on PFD to highlight Landing References ON				
		687				press enter				
		688				deactivate cursor				
		689				pressing the FMS knob				
		690				remember that Descent Checklist must be completed				
		691				get checklist from glareshield				
		692				1. pressurization - check				
		693				verify that it is set to field elevation				
		694				check that differential is decreasing				
		695				look at the horizontal differential tape on MFD				
		696				check that cabin altitude is descending				
		697				look at the vertical rate tape on the MFD				
		698								
		699				2. anti-ice/de-ice systems - as required				
						look at RAT on the PFD				

Phase of Flight	Trigger	High Level	ATC / Traffic / ATIS / AMOS	Radios	First Level/Risk Descriptor	Second Level	Third Level	Fourth Level	Notes	# physical steps (i.e. more notes)
		700					This temp is within 10 degrees of OOC decide to leave anti-ice on			
		701			3. throttles - set for descent	checked and done				
		702			4. altimeter transition check					
		703								
		704				Complete			have already descended below 18,000 ft	
		705			5. set landing bugs	press THIRREF softkey on PFD				
		706								
		707					use large FMS knob to scroll cursor to highlight Vap			
		708						checked correct and on		
		709								
		710						checked correct and on		
		711			6. landing lights - as required					
		712								
		713								
		714			note that descent checklist is complete except for altimeter transition check					
		715			put checklist away on top of glareshield					
		716			complete FL180 transition checklist					
	aircraft is at 18,000 ft MSL	717			1 Com1 Active: Wash Center 1 Com1 Standby: Polonac 3 Dep 3 Com2 Monitor: Guard Com2 Standby: HSP AMOS					
		718			Note that passing through FL180	look at altimeter, see flashing of altimeter setting (STD BARO)				
		719			remember that you must complete transition checklist and reset altimeter					
		720			recall that previously put KHSP altimeter setting in Standby Altimeter from ATC					
		721				look at standby altimeter			see setting of 29.86	
		722			Set PFD altimeter to 29.86					
		723				Twist BARO button on PFD			hard dedicated button on side of PFD screen	
		724				verify 29.86 on PFD at bottom of ALI tape				
		725			Check pressurization					
		726				verify cabin altitude				
		727				lock at cabin rate tape to verify cabin altitude is descending				
		728				verify cabin differential				
		729				lock at number above cabin altitude tape on WFD - should be green				

Phase of Flight	Trigger	High Level	ATC / Traffic / ATIS / AMOS	Radios	First Level/Risk Descriptor	Second Level	Third Level	Fourth Level	Notes	# physical steps (8 more notes)
		730			Defeat turning on taxi/landing lights because you are still in the clouds					
	Aircraft is at CSN	731	Turn over CSN	Com1 Active: Wash Center Com1 Standby: Polomac Com2 Monitor: Guard Com2 Standby: HSP AMOS	Monitor aircraft turn	look at heading display on PFD feel aircraft turning				
		732								
		733								
		734		Com1 Active: Wash Center Com1 Standby: Polomac Com2 Monitor: Guard Com2 Standby: HSP AMOS						
		735	Respond to cb pop sound and CAS amber message ANTSKID FAIL		Hear pop sound Check CAS message	Note that amber ANTSKID FAIL message has appeared			Amber CAS messages are listed alphabetically under tab B	
	Aircraft is at CSN	736								
		737								
		738								
		739			locate and retrieve emergency checklist					
		740			Open to Tab B Locate ANTSKID FAIL checklist					
		741				Note that it is the 4th checklist down on table of contents under amber CAS messages				
		742								
		743			Turn to TAB X Item 2					
		744			Read and follow checklist					
		745				Read condition statement 1st item = ANTSKID switch ---OFF THEN ON			This message is indicates that the anti-skid system is inoperative	
		746				Flip switch off then on Look to see if CAS message has disappeared (4th)				
		747								
		748				CAS message does not				
		749				2nd item = SKID CONTROL circuit breaker -- CHECK			CAS message remains on left circuit breaker panel	
		750								
		751				Note that it is popped Note that is has not been reset and you are able to do so			This action is not specified in checklist	
		752			Reset circuit breaker				ign breaker from front on second row left panel	
		753							CAS message remains	
		754								
		755			Note need to continue checklist					
		756			Read conditional statement				If message does not clear - ON GROUND or IN FLIGHT	
		757			Decide on IN FLIGHT item					
		758			3rd item = ANTSKID Switch --- OFF					
		759				Flip switch off				
		760			4th item = Landing distance	Decide to figure out landing distance now				
		761								

Phase of Flight	Trigger	High Level	ATC / Traffic / ATIS / AMOS	Radios	First Level/Risk Descriptor	Second Level	Third Level	Fourth Level	Notes	# physical steps (8 more notes)
		762				Locate and retrieve normal procedures book				
		763				Turn to APPROACH/LANDING tab				
		764				Go to 4000ft table	Recall landing weight is 6500lbs		Because our field elevation is close to 379ft	
		765					Find 6500 lb column			
		766					Correctness of temperature at KHSP, 11°C			
		767					Find 10 degree line on table			
		768					Read landing distance from chart			
		769						2200ft		
		770				Go back to emergency checklist step 4				
		771				Realize that you will land with stall warning normal because temperature will be above 100C and you will have turned off ANTI-ICE system before landing				
		772				Look at stall warning normal multiplier: 1.39				
		773					Realize you can't multiply by 1.39 and decide to use 1.5 instead			
		774					Figure 2200 times 1.5 = 3300ft			
		775				Compare computed landing distance to available landing distance via airport diagram				
		776				Note that available landing distance is 2000ft more than required				
		777					Feel confident that landing distance is enough			
		778				Continue reading checklist				
		779				Read first caution statement - WITH THE ANTI-SKID OFF, ANTI-SKID TOUCHDOWN PROTECTION IS LOST. ENSURE BRAKES ARE NOT APPLIED DURING TOUCHDOWNS.				
		780					Decide no change to plan is required			
		781				2ND - APPLY WHEEL BRAKES LIGHTLY. DIFFERENTIAL POWER BRAKING IS AVAILABLE. HOWEVER, SINCE THE ANTI-SKID IS INOPERATIVE, EXCESSIVE BRAKE PEDAL PRESSURE MAY CAUSE THE WHEEL BRAKES TO LOCK RESULTING IN TIRE BLOWOUT				

Phase of Flight	Trigger	High Level	ATC / Traffic / ATIS / AMOS	Radios	First Level/Risk Descriptor	Second Level	Third Level	Fourth Level	Notes	# physical steps (8 more notes)
		782				3RD - WHEN LANDING WITH STALL WARN-NORM, AVOID RUNWAYS WITH A DOWNHILL GRADIENT. IF A DOWNHILL RUNWAY GRADIENT CANNOT BE AVOIDED, REDUCE MAXIMUM LANDING WEIGHT BY 180LBS.	Realize you should not utilize maximum braking (use gentle braking for roll out)			
		784				Read - Procedure complete	Check airport diagram for gradient and note there is none			
		785				Close and stow emergency checklist under FMS console on floor	Note you are done with checklist			
		786								
		787								
		788								
	aircraft is at 17,000 ft MSL	789								
		790								
		791								
		792								
		793								
		794								
		795								
		796								
		797								
		798								
		799								
		800								
		801								
		802								
	aircraft is at WITTO	803								
		804								
		805								

Phase of Flight	Trigger	High Level	ATC / Traffic / ATIS / AMOS	Radios	First Level/Task Descriptor	Second Level	Third Level	Fourth Level	Notes	# physical steps (i.e. more notes)
		806			Call ATC back and acknowledge new clearance					
		807				press push to talk			"Descend pilot's discretion 15 NE of Montebello at 10,000. XXXXX"	
		808	Build the VNAV Path		Realize that this will require a VNAV Path Descend Bring up the Flight Plan page on MFD					
		809								
		810			press FPL button on center console					
		811			Enter an offset point					
		812				activate the cursor				
		813					press FMS button on center console			
		814				highlight MCL		turn the large FMS knob		
		815				create Along Track Offset				
		816								
		817					press the ATK OFST softkey		This creates a new line on the flight plan above MCL and looks like the current MCL line	
		818					Type in - minus 15 miles in distance field			
		819					Move cursor to altitude field			
		820					Enter 10000	Twist large FMS knob		
		821					Press enter	Using keypad		
		822					Turn cursor off			
		823						Press FMS knob		
		824								
		825								
		826								
		827			Activate VNAV profile					
		828				Set altitude alerter to 10000				
		829				Press VNAV ENBL softkey on MFD	Turn ALT knob on autopilot panel			
		830					Note VPTH in white on PFD command line		4th from left on MFD	
		831								
		832								
	Aircraft is at MTR	833	Begin Lost Pilot Scenario - Respond to ATC request for help in communicating with a lost aircraft							
		834	Aircraft intercepts VNAV path							
		835							vertical profile	
		836			VNAV oral warning					
		837			Pilot checks PFD command line					
		838							occurs 30 seconds prior to descent start	
		839			Pilot checks VNAV glide slope indicator					
		840							Pilot sees magenta caret moving down the altitude tape towards his altitude	
		841			Nose pitches down				upon interception aircraft pitches down	
		842			Pilot configures for descent					

Phase of Flight	Trigger	High Level	ATC / Traffic / ATIS / AMOS	Radios	First Level/Task	Second Level	Third Level	Fourth Level	Notes	# physical steps (if more notes)
		868								
		869								
		870	XXXXX Roger		ATC Acknowledges	press push to talk			pilot says "Washington center, Cleaton XXXXX, XXX descending 10000"	
		871			remember that we are now talking to last approach controller before going to CTAF	pilot listens				
		872								
		873			decide now is a good time to put CTAF frequency in the standby of the COM 1					
		874			set CTAF frequency	Refer to CTAF frequency on approach plate			Unicom frequency is 123.0	
		875				Identify which radio is in use				
		876				turns in standby using big knob...			active frequency text is green	if you want to tune the other radio, press the COM knob once
		877				...and little knob			123	
		878							0	
		879		Com1 Active: Wash Center 2 Com1 Standby: HSP CTAF Com2 Monitor: Guard Com2 Standby: HSP AMOS						
		880	aircraft is at 11,000 ft. MSL		Monitor descent to 10000					
		881			at 11,000 ft. hear altitude chime and note flashing reverse video	look at altimeter	verify (audibly) "11,000 descending 10,000" while pointing		Concurrent task!	
		882								
		883								
		884			monitor the altitude tape to verify level off					
		885			200 ft. above 10,000 note flashing and reverse lighting of altitude preseted number at the top of the altitude tape					
		886			ALT on PFD turns from white to green					
		887			Note that pitch attitude increases to level					
		888			Pilot increases power to maintain airspeed					
		889			move throttles initially to cruise detent and then as required					
		890			look at airspeed indicator to keep airspeed below redline				CODA note - pilot will keep monitoring	
		891			verify altitude capture					
		892				Pilot notes normal video on PFD altitude selection display				
		893				verify green ALT mode on PFD				
		894								
		895	aircraft is 10 nm before MOLA		Respond to controller's clearance	monitor pitch change				
		896			Cleaton XXXXX, you can exped the ILS approach runway 25 at Ingalis Field. Advise when you have the weather	Com1 Active: Wash Center 2 Com1 Standby: HSP CTAF Com2 Monitor: Guard Com2 Standby: HSP AMOS				
		897			ATC gives pilot information re: clearance for approach	Pilot listens				

Phase of Flight	Trigger	High Level	ATC / Traffic / ATIS / AMOS	Radios	First Level/Task Descriptor	Second Level	Third Level	Fourth Level	Notes	# physical steps (if more notes)
		898			Pilot calls ATC and repeats clearance					
		899				press push to talk			"Departing Montebello heading 294, expect L.S. will advise on one-minute weather"	
		900			Set heading bug	Turn heading knob on autopilot panel to 294			Set for future	
		901								
		902			Activate AMOS frequency on COM 2					
		903				Select COM 2				
		904					Press COM button on PFD			
		905					Pilot notes blue box around backup frequency on COM 2			
		906				Press <-> button				
		907								
	make this available when aircraft is 50 miles from Hot Springs	908			Listen to AMOS	get pen to write down updated AMOS			ATC SME will have to elapse time on stop watch to give proper time	
		909				Copy updated AMOS			this is second retrieval of AMOS	
		910			Activate guard frequency on COM 2					
		911				Press <-> button				
		912			Pilot enters HSP altimeter setting on PFD					
		913				Turn baro knob on PFD				
		914					Verify correct baro setting on PFD			
		915			Pilot enters HSP setting on standby altimeter					
		916				Turn baro knob on standby altimeter				
		917					Verify correct baro setting in Kollsman window			
		918								
		919								
		920			Pilot calls ATC	Press COM button on PFD				
		921				push to talk			"Washington Center, XXXXX has one-minute weather"	
		922								
	Pilot reports that he/she has current AMOS information for Hot Springs	923								
		924			ATC Acknowledges	pilot listens				
		925			recall that since K-HSP uses Unicom radio, no need to put a separate ground frequency in backup radio					
	Aircraft is at Montebello VOR	926								
		927			Fly heading 294	Press heading mode on autopilot panel			interesting to note how many fly heading mode 294 degrees or let automation sequence automatically to IRAVU	
		928				Confirm heading mode on autopilot command line on PFD				

Phase of Flight	Trigger	High Level	ATC / Traffic / ATIS / AMOS	Radios	First Level/Task Descriptor	Second Level	Third Level	Fourth Level	Notes	# physical steps (i.e. more notes)
		929			Note aircraft banking and turning to heading					
	Aircraft is at Montebello VOR	930	"Citation XXXXX, 17 miles from IFAVU, proceed direct to IFAVU, maintain 8000 until IFAVU cleared for the straight-in ILS runway 25 approach at Hot Springs"		ATC issues approach clearance				Occurs 11M part Montebello	
		931			Pilot calls ATC and repeats clearance	Pilot listens to ATC				
		932				press push to talk			Pilot says "Direct IFAVU 8000 cleared for approach, XXXXX"	
	Pilot reads back approach clearance correctly	933	"Citation XXXXX, read back correct"						This activates a direct-to window with IFAVU as the next point.	
		934			Pilot presses direct-to button on FMS	Verify IFAVU is the next point				
		935			Activate approach	Press enter				
		936			Descend to 8000	Press APR on autopilot control panel				
		937				Select 8000 on altitude alerter				
		938				Turn altitude knob on autopilot control panel				
		939				Set up vertical speed of 1500ft per minute				
		940				Press VS button on autopilot control panel				
		941				Turn whizz wheel to give 1500ft per minute rate on PFD				
		942				Verify VS mode active on PFD				
		943				Verify ALT is armed on PFD				
		944								
		945								
		946								
		947								
		948								
	pilot decides when	949			remember that you need to do approach checklist and that you like to do approach checklist as read and do and may even need to delay some items					
		950			get checklist from glasses/hood					
		951			1. pressurization					
		952				look at cabin altitude and see that it is approaching field elevation				
		953				look at differential pressure and see that it is really small				
		954				2. seats and belts - adjusted and secured				
		955				grab shoulder harness and make sure it is still on				
		956				grab the seat belt and make sure still secure				
		957				3. avionics and flight instruments				
		958				check com frequencies				
		959				look at approach plate			CTAF frequency	

Phase of Flight	Trigger	High Level	ATC / Traffic / ATIS / AMOS	Radios	First Level/Risk	Second Level	Third Level	Fourth Level	Notes	# physical steps (if more notes)
		960								
		961				do scan of flight director line of PFD to review vertical and nav modes	confirm that you are in GPS mode and VS mode with ALT armed			
		962								
		963			4. minimums	verify that minimums have already been set				
		964								
		965								
		966								
		967			5. max safety switch - set	decide to ignore because				
		968			6. max seats (upright) - check	decide to ignore because				
		969								
		970				decide to ignore because				
		971			7. fuel transfer knob - off	decide to ignore because				
		972			8. anti-ice/ice systems	look at knob and confirm arrow pointing up				
		973			8. anti-ice/ice systems (as required)	know that they are currently off and you are in warmer air so decide to keep them off				
		974			9. Landing lights - on	checked and done				
		975			10. Flap handle to TO/AFR	decide to wait until passed IF/AVU before doing that				
		976								
		977								
		978								
		979			11. CAS messages - check	press messages softkey (MSG - far right key) on PFD				
		980								
		981								
		982								
		983								
		984								
		985								
		986								
		987								
		988								
		989								
		990								
		991								

Phase of Flight	Trigger	High Level	ATC / Traffic / ATIS / AMOS	Radios	First Level/Task Descriptor	Second Level	Third Level	Fourth Level	Notes	# physical steps (8 more notes)
		992			monitor the altitude tape to verify level off					
		993			200 ft. above 8,000 note flashing and reverse lighting of altitude preset number at the top of the altitude tape					
		994			ALT on PFD turns from white to green					
		995			Note that pitch attitude increases to level					
		996			Pilot increases power to maintain airspeed				Throttle up speed is 160kts	
		997				move throttles initially to cruise detent and then as required			CODA note - Pilot will keep monitoring	
		998				look at airspeed indicator to keep airspeed around 160 kts.				
		999			verify altitude capture					
		1000				Pilot notes normal video on PFD altitude selection display				
		1001			monitor pitch change	verify green ALT mode on PFD				
		1002								
		1003								
		1004								
		1005			Monitor crossing IFAYU and initiate descent to 6000	Look at destination and distance portions of the PFD command line.				
		1006				Select 6000 on altitude alerter				
		1007				Descend to 6000				
		1008								
		1009				Set up vertical speed of 1500ft per minute	Turn altitude knob on autopilot control panel			
		1010								
		1011					Press VS button on autopilot control panel			
		1012					Turn whiz wheel to give 1500ft per minute rate on PFD			
		1013				Verify VS mode active on PFD				
		1014				Verify ALT is armed on PFD				
		1015			Monitor descent to 6000ft					
		1016			aircraft is at 7,000 ft. MSL.					
		1017			at 7,000 ft. hear altitude chime and note flashing reverse video	look at altimeter			Concurrent task!	
		1018								
		1019								
		1020			monitor the altitude tape to verify level off					
		1021			200 ft. above 8,000 note flashing and reverse lighting of altitude preset number at the top of the altitude tape					
		1022			ALT on PFD turns from white to green					
		1023			Note that pitch attitude increases to level					
					Pilot increases power to maintain airspeed				Throttle up speed is 160kts	

Phase of Flight	Trigger	High Level	ATC / Traffic / ATIS / AMOS	Radios	First Level/Risk Descriptor	Second Level	Third Level	Fourth Level	Notes	# physical steps (8 more notes)
		1024				move throttles initially to cruise detent and then as required look at airspeed indicator to keep airspeed around 160 kts.			CODA note - pilot will keep monitoring	
		1025								
		1026			verify altitude capture	Pilot notes normal video on PFD altitude selection display verify green ALT mode on PFD				
		1027								
		1028								
		1029			monitor pitch change					
		1030								
	Aircraft is at IEAVU (IAP)	1031			Extend flaps to approach	Look at airspeed indicator and verify that you are under 180kts Lower flaps	Place flap lever in approach detent			
		1032								
		1033								
		1034								
		1035				Confirm the flaps are in approach				
		1036					Look at flap indicator on MFD			
		1037			Recall that flaps remained to be done on approach checklist say "approach checklist complete except for flaps and gear"					
		1038								
		1039			Monitor turn at AHLER					
	Aircraft is at AHLER	1040			Aircraft turns to 247	Note aircraft is turning to inbound course Note that flight plan has sequenced to the next point DURAN				
		1041								
		1042								
		1043			Magenta CDI is replaced with a green CDI on PFD	Note CDI is now green Verify inbound course of 247				
		1044				Verify that CDI is active and captured				
		1045								
		1046								
		1047			Check to make sure that you are still in approach mode on PFD command line					
		1048			Check to make sure that glide slope is active and above your altitude					
		1049				Check PFD glide slope diamond				
		1050				Verify GS armed on PFD command line				
		1051								
		1052			Reduce airspeed below 150Kts Note that RA has been greater than 10 for several minutes					
		1053			Realize that de-icing can be turned off and Vap and Vev can be reset					
		1054			Turn off wing and engine de-icing equipment					
		1055				Flip surface de-icing switch to OFF				

Phase of Flight	Trigger	High Level	ATC / Traffic / ATIS / AMOS	Radios	First Level/Risk Descriptor	Second Level	Third Level	Fourth Level	Notes	# physical steps (8 more notes)
		1056				Recall stall warning device switch needs to be reset to normal	Flip stall warning device switch to RESET and release (spring loaded flip)			
		1057					Check CAS message to see if stall warning HI is gone			
		1058								
		1059				Recall that Vap and Vref speeds for anti-ice systems off condition have been calculated and written down	Flip left and right engine anti-ice switches to OFF			
		1060							Assume Vap = 102, Vref = 102 and approach flaps is maximum setting if anti ice is on. If anti-ice is off Vap = 91 kts, Vref = 85 kts	
		1061				Enter updated Vap and Vref				
		1062				Refer to written notes for Vap and Vref				
		1063				activate TM/REF function	Press TM/REF socketkey on PFD		automatically activate cursor	
		1064				highlight Vap				
		1065				highlight Vap	twist large FMS knob on PFD to select Vap			
		1066				set Vap	twist small FMS knob to enter 91			
		1067					twist large FMS knob to select Vref			
		1068				highlight Vref	twist small FMS knob to enter 85			
		1069								
		1070								
		1071				set Vref				
		1072								
		1073				Note glideslope diamond approaching current altitude			Note that glideslope is alive	
	runway 25 glideslope indicator becomes "alive"	1074								
		1075				Note aircraft pitching nose down				
		1076				Check GS active on PFD				
		1077				command line			In command line goes from white to some other color	
		1078				Complete before landing flow				
	1078 pilot decides when	1079				Gear down				
		1080				Place gear handle in down position				
		1081				Notice red transit light next to gear handle				
		1082				Note 3 green lights and no red lights next to gear handle				
		1083				Set landing flaps				
		1084				Verify speed is below 150kts				
		1085				Move flap lever to landing position				
		1086				Check flap indicator on MFD				
		1087				Check speed brakes down				

Phase of Flight	Trigger	High Level	ATC / Traffic / ATIS / AMOS	Radios	First Level/Risk Descriptor	Second Level	Third Level	Fourth Level	Notes	# physical steps (8 more notes)
		1088			Set missed approach altitude	MFD				
		1089			Recall missed approach altitude equals 6000 (or verify on chart)					
		1090			Set altitude alerter to 6000					
		1091					Twist ALT knob on autopilot panel			
		1092			Monitor airspeed					
		1093				Monitor airspeed to make sure that you don't go below Vref (85 Kts)				
		1094								
		1095		Com1 Active: Wash Center 2 Com1 Standby: HSP C/AF Com2 Monitor: Guard Com2 Standby: HSP AMOS	Recall that you must complete before landing checklist					
	pilot decides when	1096			Recall that you must complete before landing checklist					
		1097			Pull checklist out from glare shield					
		1098			1. Landing gear					
		1099			2. Speed brakes	Checked down, done				
		1100			3. Flaps	Checked retracted, done				
		1101			4. Pressurization	Checked landing, done				
		1102			5. Autopilot and Yaw damper	Check zero differential	Look at horizontal differential tape on MFD			
		1103			6. Airspeed - Set to VREF	Remember you need to turn off when decision altitude is reached				
		1104			Note checklist complete, except for autopilot and yaw damper	Airspeed between Vref and Vref +10				
		1105			Slow checklist on glare shield					
		1106								
		1107								
		1108								
		1109								
		1110								
		1111								
		1112								
	Aircraft is at final approach fix (DUFAN, outer marker)	1113	Respond to ATC instruction to change to C/AF frequency	Caution XXXXX, radar service is terminated, frequency changes to advisory approved, report canceling IFR on this frequency in the air or on the ground with Leesburg flight services on 122.0	Com1 Active: Wash Center 2 Com1 Standby: HSP C/AF Com2 Monitor: Guard Com2 Standby: HSP AMOS	ATC gives pilot instruction to go to C/AF frequency	Pilot listens			
		1114								
		1115								
		1116			pilot acknowledges instruction					
		1117				press push to talk			Going to Unicom, XXXXX, Thanks	
		1118			Verify crossing altitude (6003 ft)					
		1119			Verify approach is stable	Look at altimeter				
		1120				Check aircraft configuration				
		1121								
		1122					Full flaps			
		1123					Clear down			

Phase of Flight	Trigger	High Level	ATC / Traffic / ATIS / AMOS	Radios	First Level/Risk Descriptor	Second Level	Third Level	Fourth Level	Notes	# physical steps (8 more notes)
		1124								
		1125				Airspeed between Vref and Vref +10 On glide path				
		1126				On localizer				
		1127			Select CTAF Frequency Recall CTAF frequency/ is in standby for COM 1					
		1128								
		1129								
		1130			Com1 Active: Wash Center 2 Com1 Standby: HSP CTAF Com2 Monitor: Guard Com2 Standby: HSP AMOS	activate frequency/			verification of correct freq being entered is done as action is performed	
		1131			Com1 Active: HSP CTAF Com1 Standby: Wash Center 2 Com2 Monitor: Guard Com2 Standby: HSP AMOS	press <->				
		1132			Report position on CTAF frequency		check that the active frequency is now 123.0		freq check	
		1133								
		1134				press push to talk			"HSP traffic, Cleton XXXX 3.5 mile final runway 25 hot springs"	
		1135			Monitor approach Configure MFD to map mode				Second level tasks are done repeatedly for the remainder of approach	
		1136								
		1137			Set range to 8nm	Twist large knob on center console clockwise			always set range to 8nm out when crossing final approach fix	
		1138				Turn range knob on center console				
		1139								
		1140			(Break out of clouds at 4788 MSL/9964GL)					
	Aircraft breaks out of clouds at 4788 MSL and has runway in sight	1141			Make decision about whether to proceed for landing visually					
		1142			Com1 Active: HSP CTAF Com1 Standby: Wash Center 2 Com2 Monitor: Guard Com2 Standby: HSP AMOS					
		1143			Decide to proceed visually approach to DA					
		1144			Continue to monitor approach to DA	Monitor glide path				
		1145				Monitor localizer				
		1146				Monitor altitude				
		1147				Monitor airspeed				
		1148					Adjust throttle to maintain Vref to Vref +10			
		1149								
		1150			Recall that landing/taxi and strobe lights are off					
		1151			Turn landing/taxi and strobe lights on	Flip landing/taxi light switch to landing				
		1152				Flip anti-collision light switch to on				
		1153			Com1 Active: HSP CTAF Com1 Standby: Wash Center 2 Com2 Monitor: Guard Com2 Standby: HSP AMOS					
	Aircraft is at 4600 ft. MSL	1154			Monitor aircraft on the field.				Trigger is when Mustang is 4600ft	
		1155			"ingalls traffic, Malibu 6349L on the active. My engine just quit. I will restart and exit the active as quickly as possible. ingalls"	disabled aircraft (traffic) on active runway reports dead engine				
		1156				Pilot realizes aircraft may not clear runway in time for landing				
						Pilot listens				

Phase of Flight	Trigger	High Level	ATC / Traffic / ATIS / AMOS	Radios	First Level/Task Descriptor	Second Level	Third Level	Fourth Level	Notes	# physical steps (i.e. more notes)
		1157			Descend to continue descent as planned for the time being but continue to monitor aircraft on the field					
		1158			Realizes that performing a go-around or a missed approach may be necessary					
		1159				Consider ceiling and visibility				
		1160				Decide to do a go-around	Realize you have plenty of altitude to do a go-around			
		1161			Decide on a point at which a go-around will occur	Decision point is at 4080ft b/c it is DA and is marked on the altimeter				
		1162								
		1163			Manually rehearse go-around	Recall briefing is not authorized south east therefore right pattern				
		1164				Recall Good bases at 4800ft, therefore pattern altitude will be 4900ft.				
		1165								
		1166								
		1167			Continue to descend and monitor					
		1168			Make decision about how to proceed for landing relative to disabled aircraft					
	Aircraft is at 4280 (500 ft. AGL)	1169		Cont Active: HSP CTAF Cont Standby: Wash Center 2 Cont2 Monitor: Guard Cont2 Standby: HSP AMOS	disabled aircraft on active runway reports engine started and working to clear the active				Altitude = 4300ft	
		1170			"Ingalls Traffic: Malibu 6349L engine restarted. Exiting runway at next taxiway, Ingalls"					
		1171			Continue descent	Pilot listens				
		1172			Look for aircraft on runway					
		1173			Look at how far he is from next taxiway and make a guess as to how long it will take for them to get there				6349L will take 30 seconds to get off runway from the time he starts engine (fuel bay between 25 and midfield taxiway)	
		1174			decide the pilot will take too long to get off runway and needs to execute go-around					
		1175			Initiate Go Around in the Pattern					
	pilot decides when	1176		Cont Active: HSP CTAF Cont Standby: Wash Center 2 Cont2 Monitor: Guard Cont2 Standby: HSP AMOS	Initiate go around				Must do a right pattern!	
		1177			Disconnect auto pilot					
		1178			Go to full throttle	Press TOGA button on throttle				
		1179			Pitch up into command bars	Push throttles to T/O detent				
		1180			Raise 1st notch of flaps	Pull back on yoke				
		1181			Monitor positive rate of climb	Flap lever to TO/APR setting				
		1182								
		1183								
		1184								
		1185								
		1186								

Phase of Flight	Trigger	High Level	ATC / Traffic / ATIS / AMOS	Radios	First Level/Risk Descriptor	Second Level	Third Level	Fourth Level	Notes	# physical steps (if more notes)
		1187				Raise gear	Gear handle up	See red transit (unsafe) light		
		1188								
		1189					See 3 green lights go out on gear display			
		1190								
		1191				Decide to leave flaps in approach configuration Turn on YAW damper				
		1192								
		1193								
		1194				Announce go around	Press YD button on autopilot panel			
		1195							"Hot Springs traffic, Mustang XXXXX, going around, right traffic, runway 25, Hot Springs"	
		1196				At 4300ft start right turn for crosswind	press push to talk			
		1197					Turn yoke to right to establish 30 degree bank Roll out heading 340			
		1198					Monitor distance from runway			
		1199								
		1200				Announce crosswind				
		1201								
		1202				Level at 4600ft	press push to talk		"Hot Springs traffic, Mustang XXXXX, right crosswind runway 25, Hot Springs"	
		1203								
		1204				At approx 4450 reduce throttle to cruise setting	Push YD button to cruise detent			
		1205								
		1206				Remember that we raised gear when decided to go around and need to extend them again	Start pitching nose down			
		1207								
		1208								
		1209				Drop gear				
		1210								
		1211				Gear handle down NOTE red transit light NOTE and call out 3 green, no tests				
		1212								
		1213				Monitor airspeed at Vref +20				
		1214				Announce downwind			"Hot Springs traffic, Mustang XXXXX, right downwind, runway 25, Hot Springs"	
		1215					press push to talk			
		1216				90 seconds after disabled aircraft called and reported that its engine had started				
		1217				Cont Active: HSP CTAF Cont Standby: Wash Center Cont Monitor: Guard Cont Standby: HSP AMOS	Aircraft (traffic) at HSP clears the active			
		1218				"Malibu 49L, clear of runway 25, Ingalls"				
		1219					Final listene Decide if its time to turn for downwind leg of go around (when appropriate) Turn yoke to right to establish 30 degree bank turn Roll out heading 070			
		1220								
		1221				Approximately at 45, turn base	Turn yoke to left			
		1222							Have WFD in map mode, set range to 8 miles, when runway reaches edge of field of view start turn	

Phase of Flight	Trigger	High Level	ATC / Traffic / ATIS / AMOS	Radios	First Level/Risk Descriptor	Second Level	Third Level	Fourth Level	Notes	# physical steps (8 more notes)
		1223				Turn yoke to right to establish 30 degree bank				
		1224				Roll out heading 170	Turn yoke to left			
		1225				Monitor angle to and distance from runway				
		1226				Adjust throttle to maintain appropriate angle				
		1227								
		1228			Announce final turn					
		1229				press push to talk				
		1230			Turn to intercept final approach	Turn yoke to right to establish 30 degree bank				
		1231				Roll out heading 247	Turn yoke to left			
		1232								
		1233								
		1234	Configure aircraft per Cessna SOP for landing	Com1 Active: HSP CTAF Com1 Standby: Wash Com2 Monitor: Guard Com2 Standby: HSP AMOS	Configure for landing					
		1235				Full flaps	Flap lever to landing detent			
		1236								
		1237				Slow to Vref to Vref +10	Adjust throttle to maintain Vref to Vref +10			
		1238								
		1239								
		1240								
		1241			Flow Check					
		1242				Check flaps	Full flaps			
		1243				Check gear	3 greens, no reds			
		1244				Check speed brakes	Speed brakes retracted			
		1245								
		1246								
		1247			Follow VASI	Maintain glide slope	Adjust pitch and power as necessary			
		1248								
		1249								
		1250								
		1251								
		1252								
		1253			Visually verify plane is off runway	Look out window on to runway 25				
		1254								
		1255								
Landing										
	aircraft is over runway at 50 ft. AGL	1256	Land Airplane	Com1 Active: HSP CTAF Com1 Standby: Wash Com2 Monitor: Guard Com2 Standby: HSP AMOS	AT 50KGL, throttles idle Fly airplane onto runway	Land on main wheels straddling center line Lower nose wheel				
		1257								
		1258								
		1259								
		1260								
		1261								
		1262								
		1263								
		1264								
		1265	Exit runway in accordance with turn-off plan and report clear of the active	Com1 Active: HSP CTAF Com1 Standby: Wash Com2 Monitor: Guard Com2 Standby: HSP AMOS	Follow leadoff center line	Apply brakes				
	aircraft has landed and slowed to taxi speed	1266								
		1267				Apply rudders and brakes as necessary				

Phase of Flight	Trigger	High Level	ATC / Traffic / ATIS / AMOS	Radios	First Level/Task Descriptor	Second Level	Third Level	Fourth Level	Notes	# physical steps (8 more notes)
		1268			Announce clear of runway 25				"Hot Springs traffic, Mustang XXXXX, clear of runway 25, Hot Springs"	
		1269				press push to talk				
End of Task Analysis		1270	<i>End Task Analysis</i>							
		1271	Configure aircraft per Cassina SOP							
		1272	Perform After Landing Checklist							
Taxi In		1273								
		1274	Taxi on taxiways to ramp	Com1 Active: HSP CTAF Com1 Standby: Wash Center 2 Com2 Monitor: Guard Com2 Standby: HSP AMOS						
		1275	Monitor SAFE TAXI page on MFD (GOOD)							
		1276	Cancel IFR Clearance with Lessing Flight Service Station							
		1277								
		1278	(If they choose to cancel IFR Clearance while airborne)							
		1279								
Engine Shutdown		1280								
		1281	Execute engine shutdown per Cassina SOP							
		1282	Perform Shutdown Checklist							

Appendix B-1. Timeline for Flight Leg 1

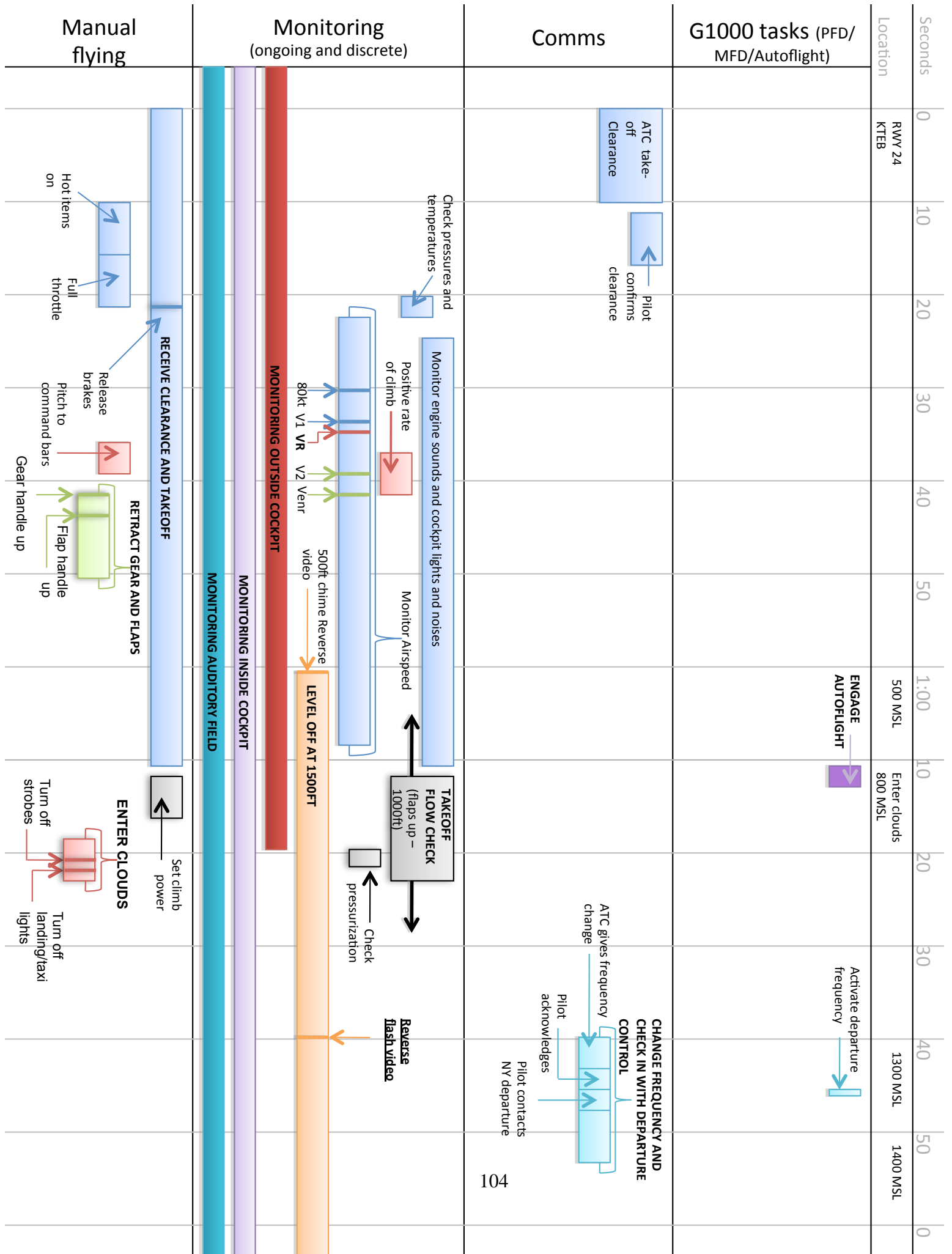

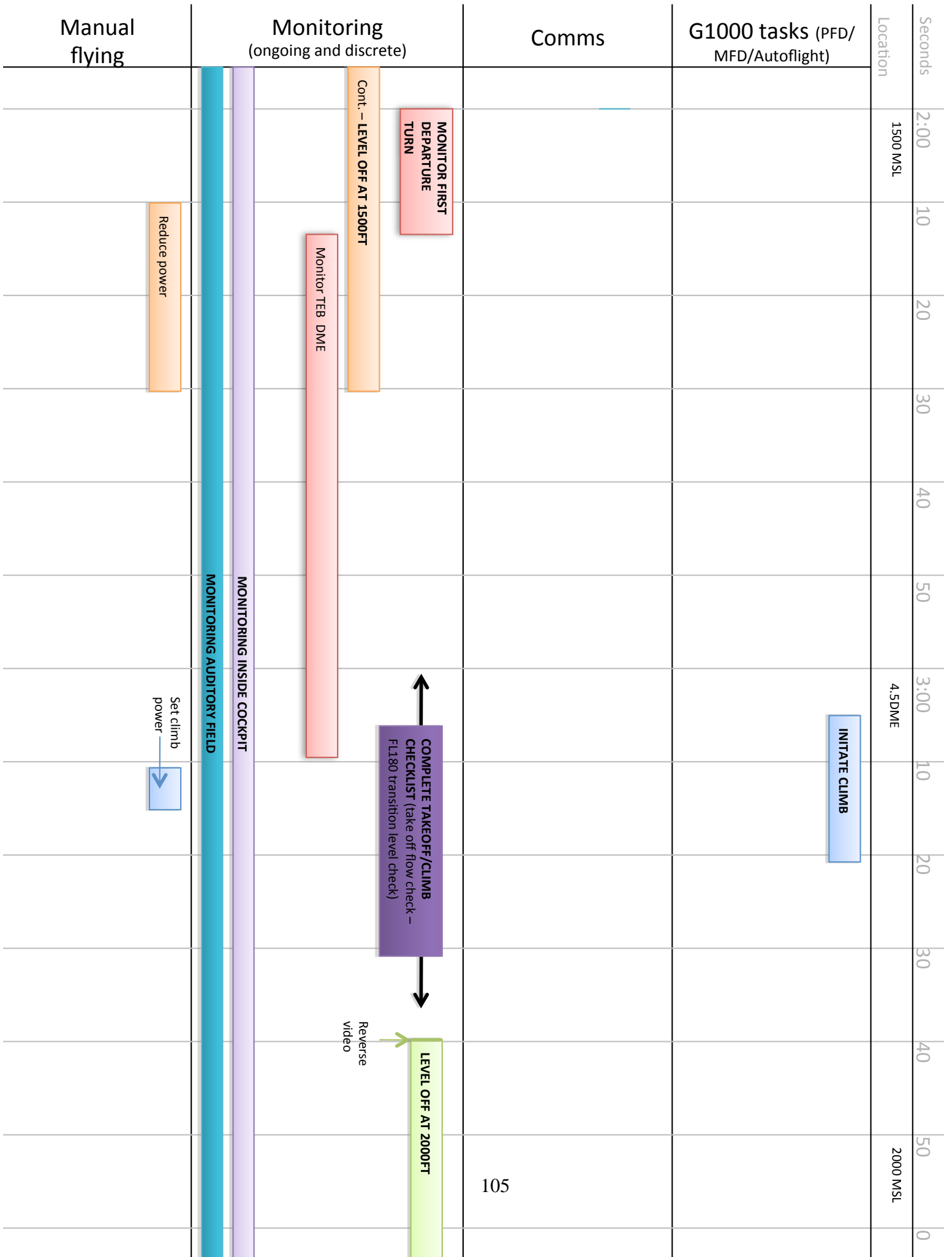

Manual flying	Monitoring (ongoing and discrete)	Comms	G1000 tasks (PFD/MFD/Autoflight)	Location	Seconds
					4:00
					10
					20
					30
					40
					50
					5:00
					10
					20
					30
					40
					50
					0

Reduce climb power

Cont. - LEVEL OFF AT 2000

Reverse flash video



Monitor for traffic on TIS or TAS

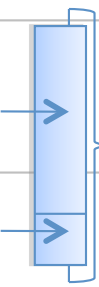

ATC informs of crossing traffic
Pilot confirms advisory, advises in IMC

RESPOND TO ATC TRAFFIC CALL

10 DME from TEB

MONITORING INSIDE COCKPIT
MONITORING AUDITORY FIELD

Manual flying	Monitoring (ongoing and discrete)	Comms	G1000 tasks (PFD/MFD/Autoflight)	Seconds	Location
				6:00	15 DME from TEB
				10	
				20	
				30	
				40	
			Entering radio frequency		
			Dial in heading		
			Set ALT button		
			Roll pitch wheel		
			Press FLC button		
			SET ALTITUDE WINDOW TO 6000		
			Monitor a/c beginning to turn	7:00	
			Monitor airspeed		
			Monitor climb		
			Set climb power		
				10	
				20	
				30	
				40	
				50	
				0	

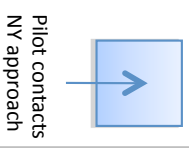
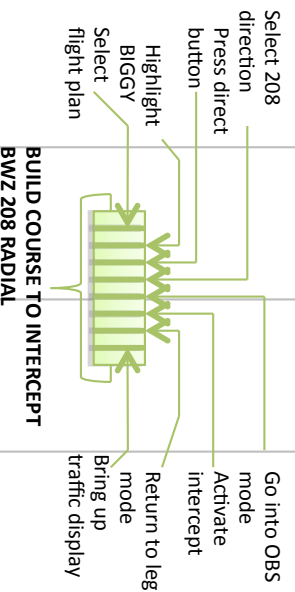
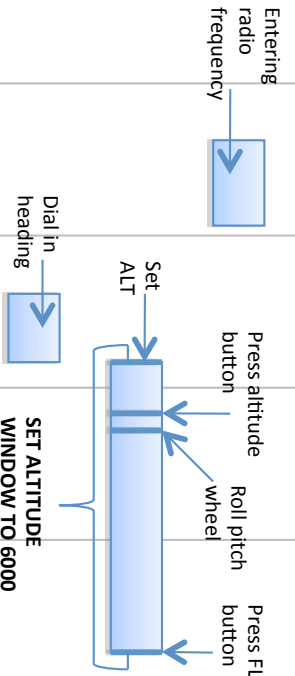
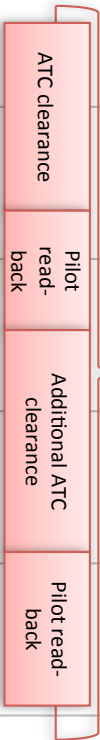

Manual flying	Monitoring (ongoing and discrete)	Comms	G1000 tasks (PFD/MFD/Autoflight)	Location	Seconds
					8:00
				5000 MSL	10
					20
					30
					40
					50
					9:00
					10
					20
					30
					40
					50
				Leaving class BRAVO	0

Reduce power

MONITORING AUDITORY FIELD

MONITORING INSIDE COCKPIT

MONITORING OUTSIDE COCKPIT

LEVEL OFF AT 6000FT

5000ft
chime
Reverse
video

Reverse
flash
video

Verify
altitude
capture

Monitor
airspeed

Manual flying	Monitoring (ongoing and discrete)	Comms	G1000 tasks (PFD/MFD/Autoflight)	Location	Seconds
					10:00
					10
					20
					30
					40
					50
				TEB 30 DME	11:00
					10
					20
					30
					40
					50
					0

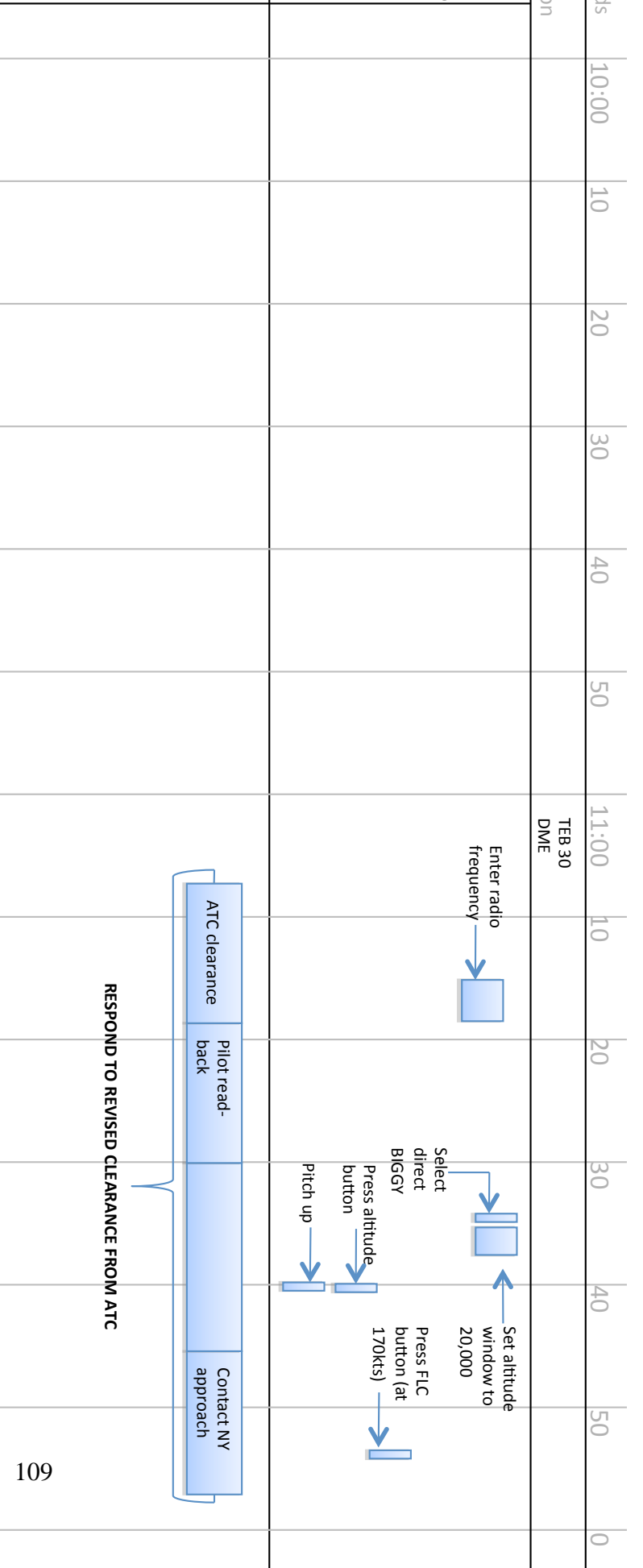
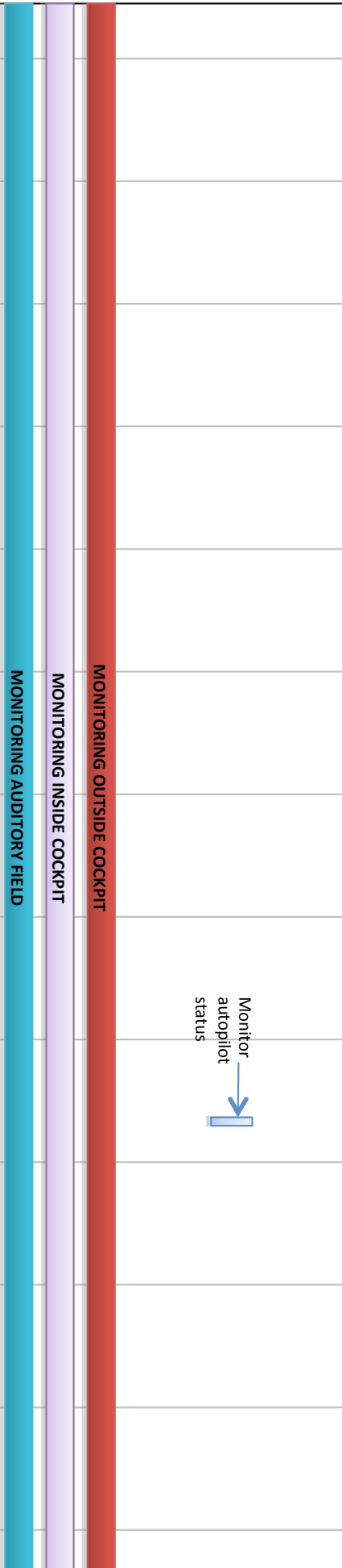
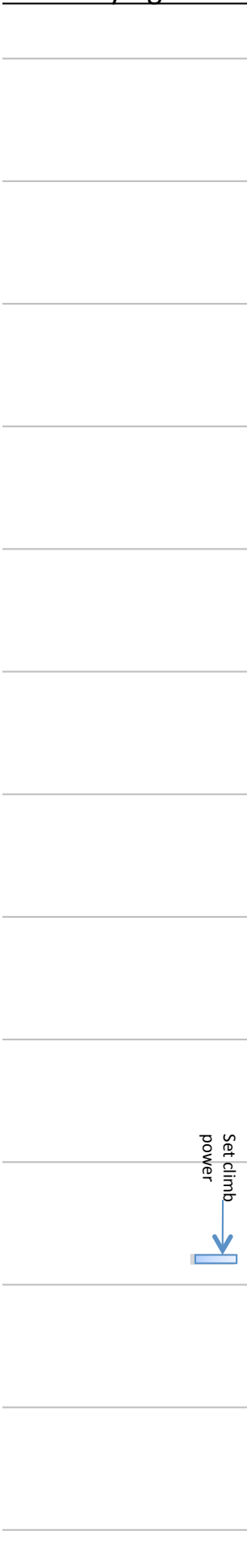

Manual flying	Monitoring (ongoing and discrete)			Comms	G1000 tasks (PFD/MFD/Autoflight)	Location	Seconds
							12:00
							10
							20
							30
							40
							50
							13:00
							10
							20
							30
							40
							50
							10000MSL
							0

MONITORING AUDITORY FIELD

MONITORING INSIDE COCKPIT

MONITORING OUTSIDE COCKPIT

110

Manual flying	Monitoring (ongoing and discrete)	Comms	G1000 tasks (PFD/MFD/Autoflight)	Location	Seconds
					14:00
					10
					20
					30
					40
					50
					15:00
					10
					20
					30
					40
					50
					0

MONITORING AUDITORY FIELD

MONITORING INSIDE COCKPIT

Manual flying	Monitoring (ongoing and discrete)	Comms	G1000 tasks (PFD/MFD/Autoflight)	Location	Seconds
				100 miles from KMTN	16:00
					10
					20
					30
					40
					50
					17:00
					10
					20
					30
					40
					50
					0

MONITORING AUDITORY FIELD

MONITORING INSIDE COCKPIT

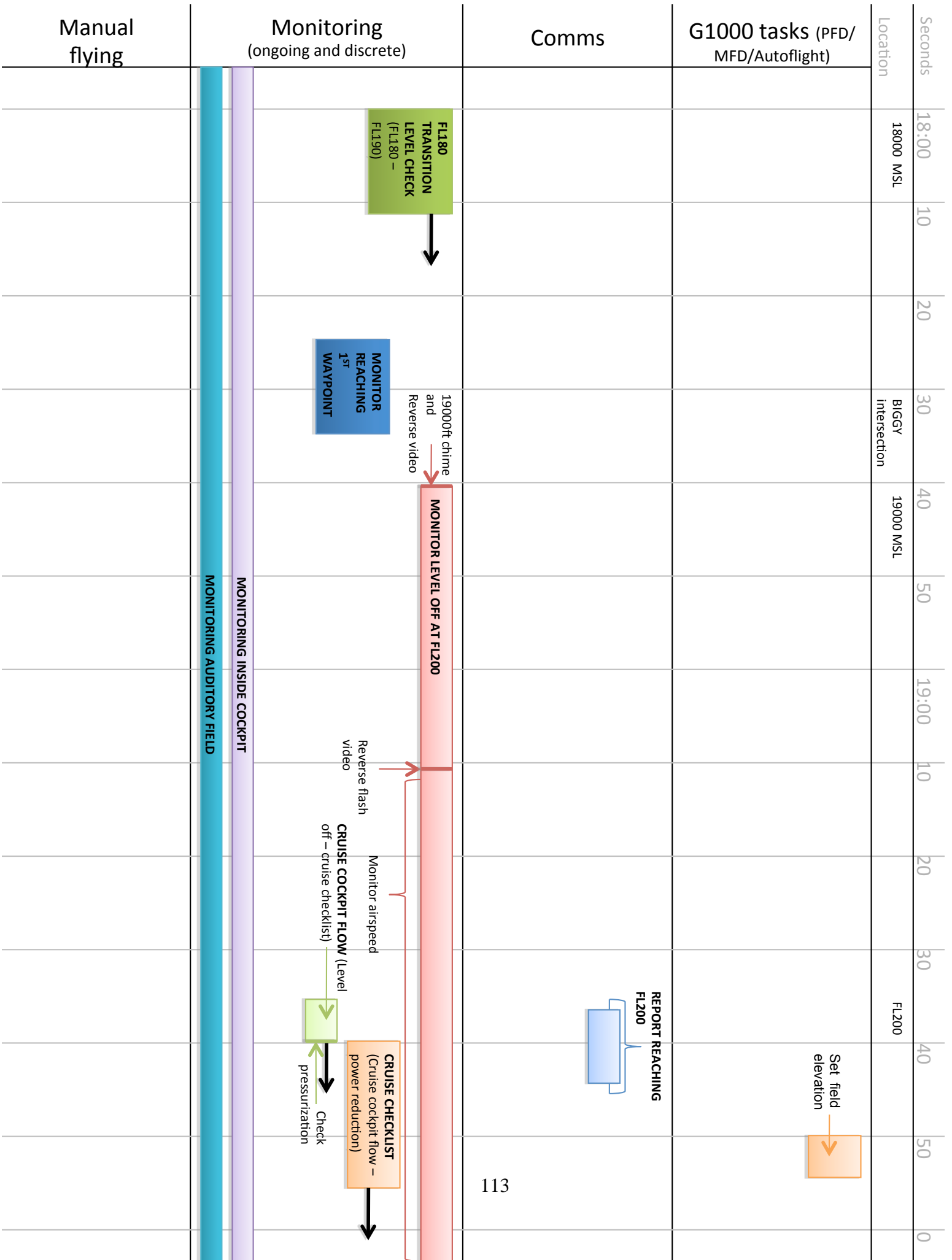

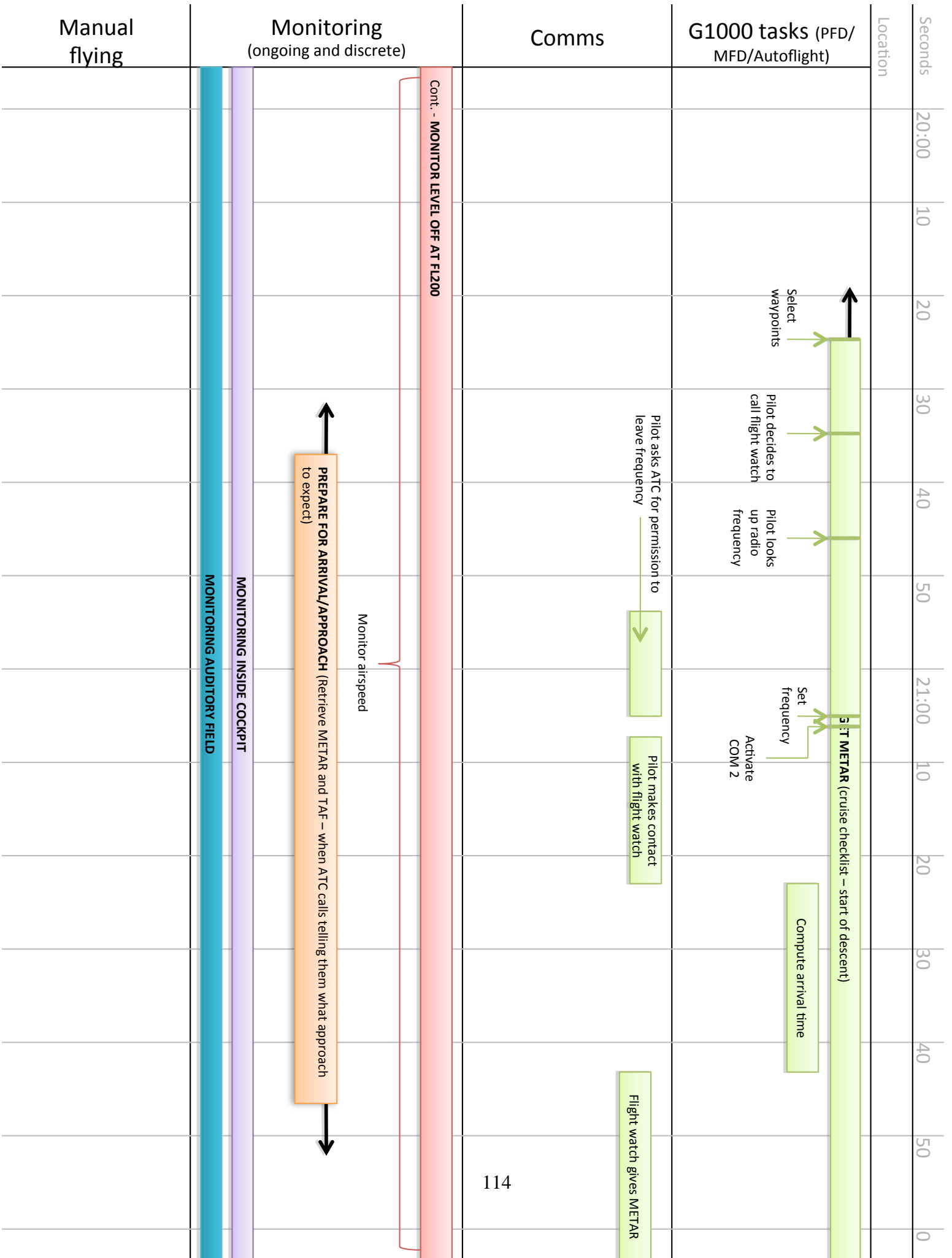

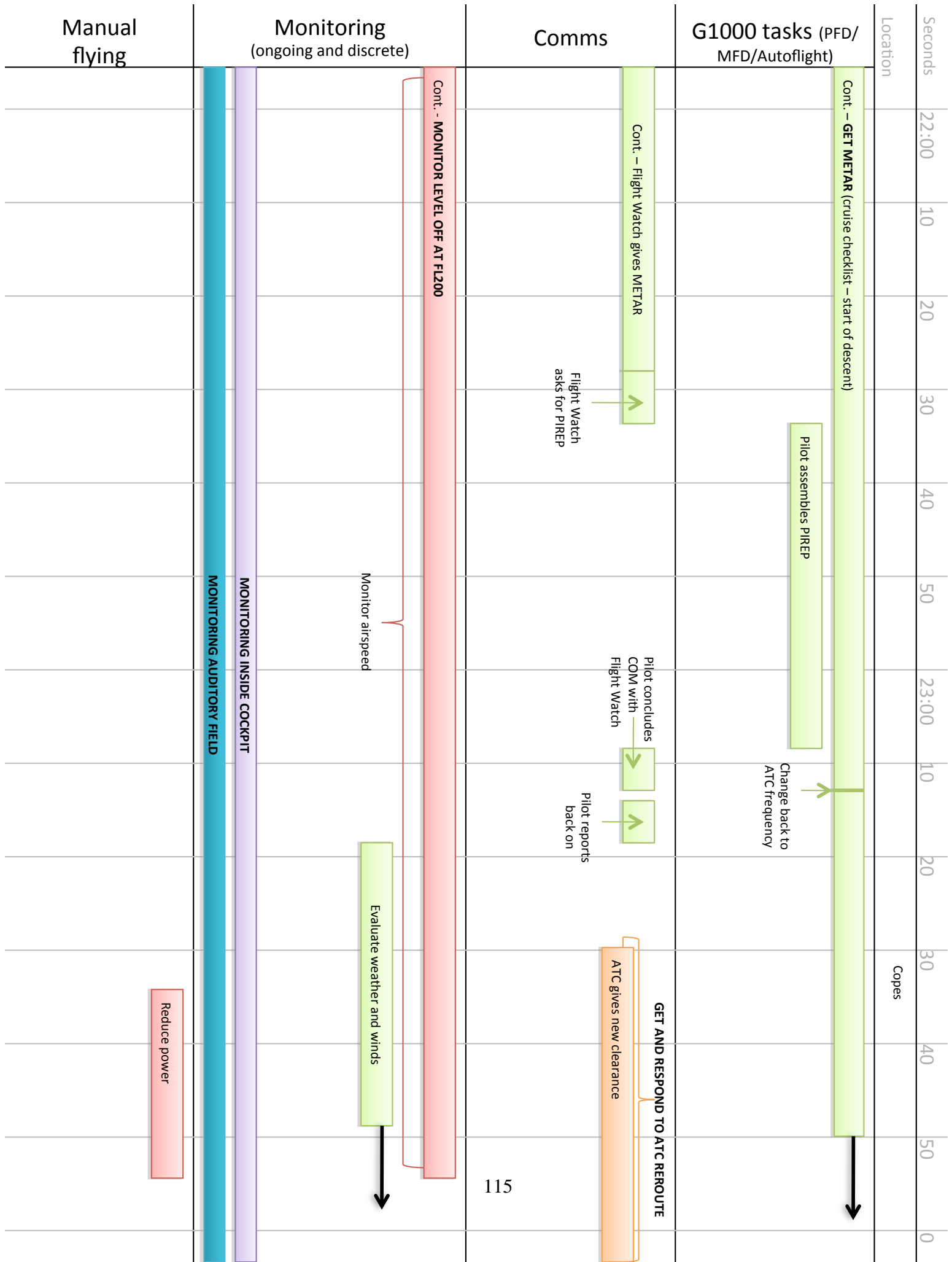

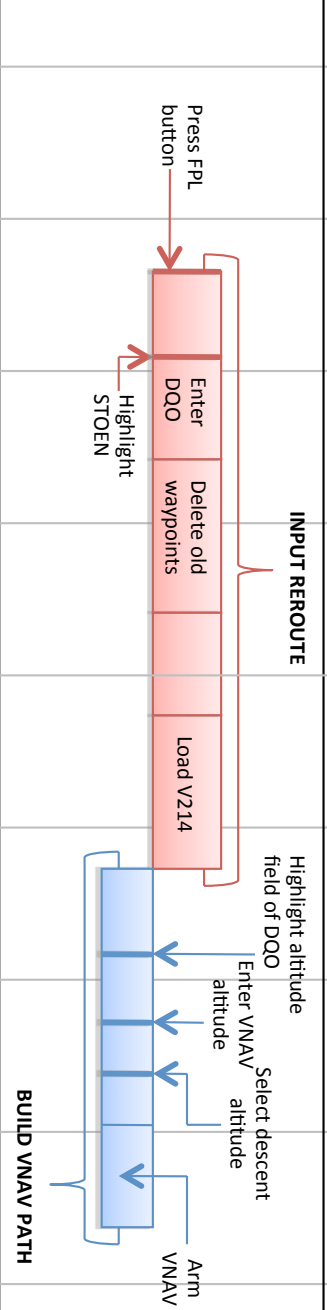
Manual flying	Monitoring (ongoing and discrete)	Comms	G1000 tasks (PFD/MFD/Autoflight)	Location	Seconds
	<p data-bbox="422 955 446 1249">MONITORING INSIDE COCKPIT</p> <p data-bbox="370 955 394 1249">MONITORING AUDITORY FIELD</p>	<p data-bbox="901 63 1031 105">Comms</p> <p data-bbox="1096 157 1120 577">Cont. - GET AND RESPOND TO ATC REROUTE</p> <p data-bbox="941 157 966 294">Pilot read-back</p>  <p>The diagram illustrates two task sequences. The first, 'INPUT REROUTE', is shown in a red box and includes steps: 'Press FPL button', 'Enter DQO', 'Delete old waypoints', and 'Load V214'. A 'Highlight STOEN' label points to the 'Enter DQO' step. The second, 'BUILD VNAV PATH', is shown in a blue box and includes steps: 'Highlight altitude field of DQO', 'Enter VNAV altitude', 'Select descent altitude', and 'Arm VNAV'.</p>	<p data-bbox="1161 63 1437 136">G1000 tasks (PFD/MFD/Autoflight)</p> <p data-bbox="1421 640 1445 798">INPUT REROUTE</p> <p data-bbox="1144 1207 1169 1396">BUILD VNAV PATH</p>	<p data-bbox="1534 42 1559 157">Location</p> <p data-bbox="1534 199 1559 294">24:00</p> <p data-bbox="1534 346 1559 399">10</p> <p data-bbox="1534 504 1559 556">20</p> <p data-bbox="1534 661 1559 714">30</p> <p data-bbox="1534 808 1559 861">40</p> <p data-bbox="1534 966 1559 1018">50</p> <p data-bbox="1534 1123 1559 1176">25:00</p> <p data-bbox="1534 1281 1559 1333">10</p> <p data-bbox="1534 1438 1559 1491">20</p> <p data-bbox="1534 1596 1559 1648">30</p> <p data-bbox="1534 1753 1559 1806">40</p> <p data-bbox="1534 1911 1559 1963">50</p> <p data-bbox="1534 2068 1559 2100">0</p>	
116					

Manual flying	Monitoring (ongoing and discrete)	Comms	G1000 tasks (PFD/MFD/Autoflight)	Location	Seconds
					26:00
					10
					20
					30
					40
					50
					27:00
					10
					20
					30
					40
					50
					0

MONITORING AUDITORY FIELD

MONITORING INSIDE COCKPIT

VPTH auditory alert and VPATH indicator

MONITOR TOD AND VNAV PATH INITIATION

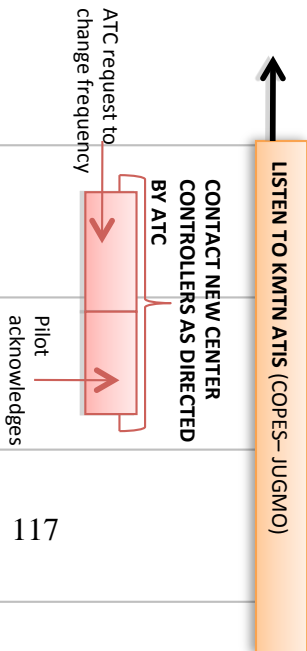

117

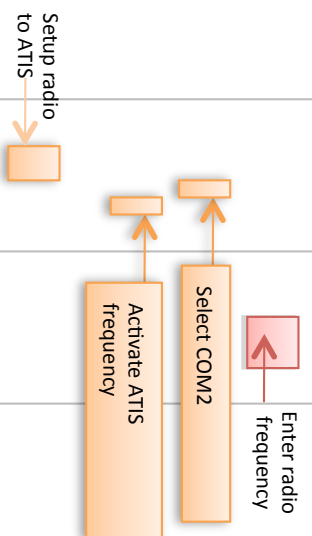

MXE

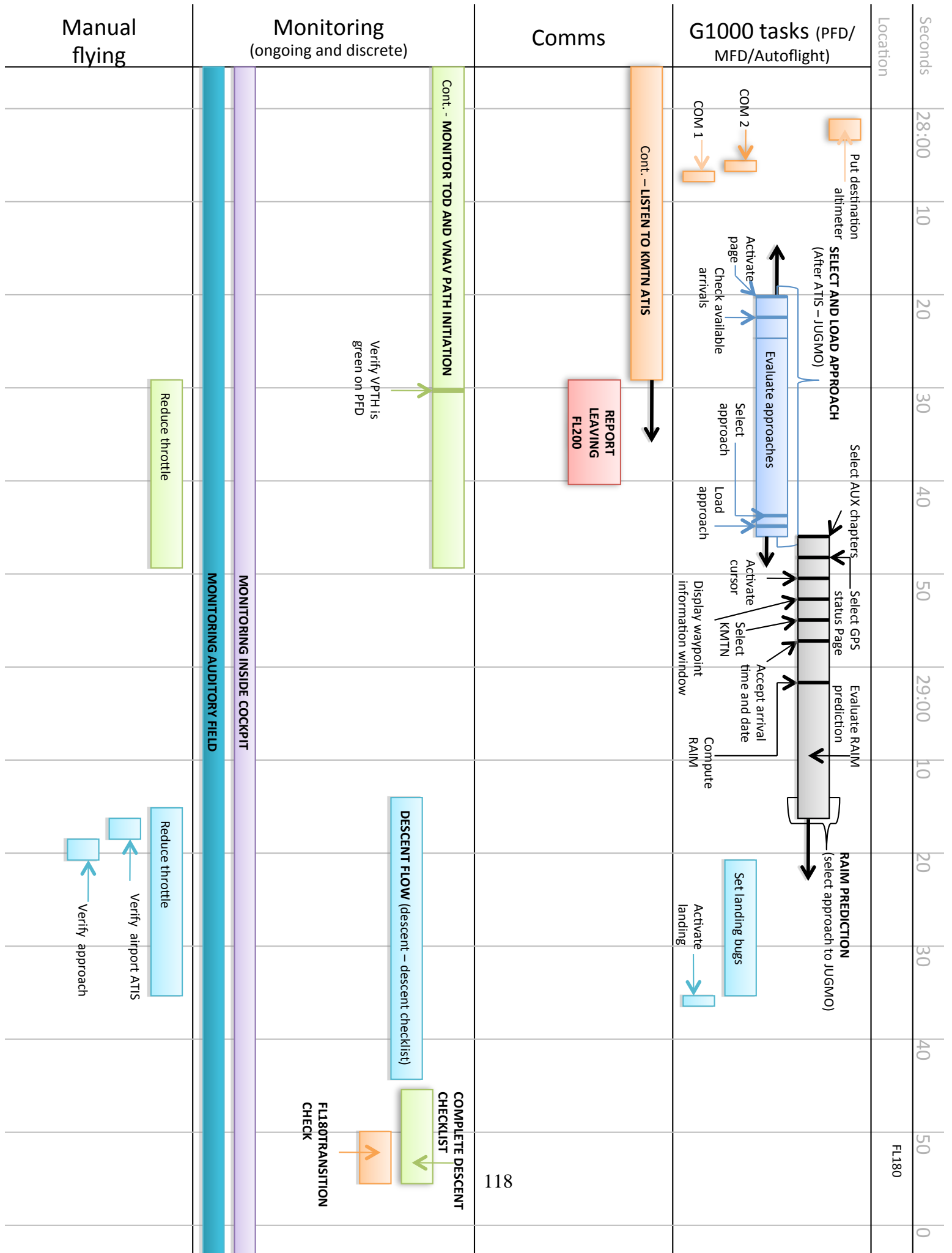

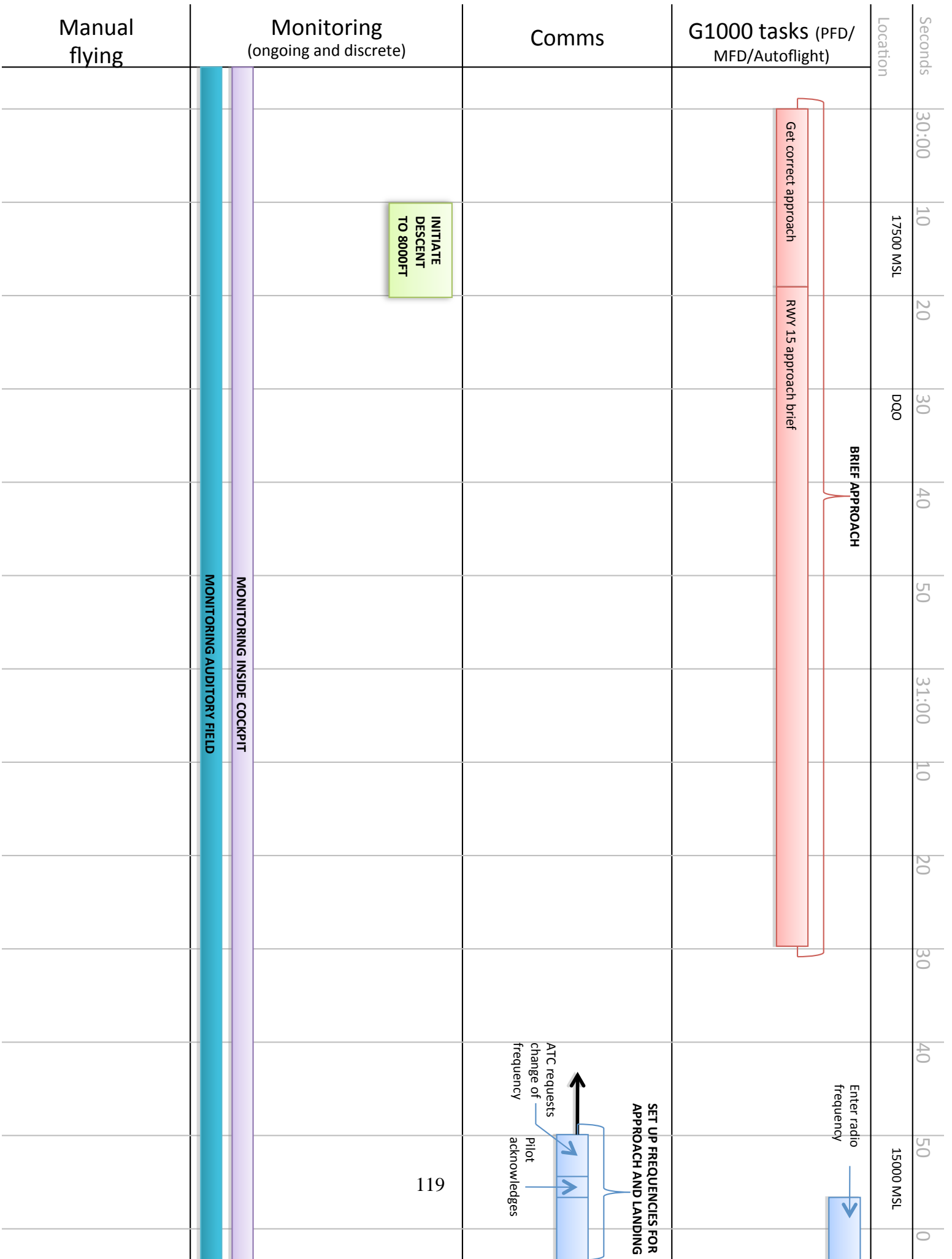

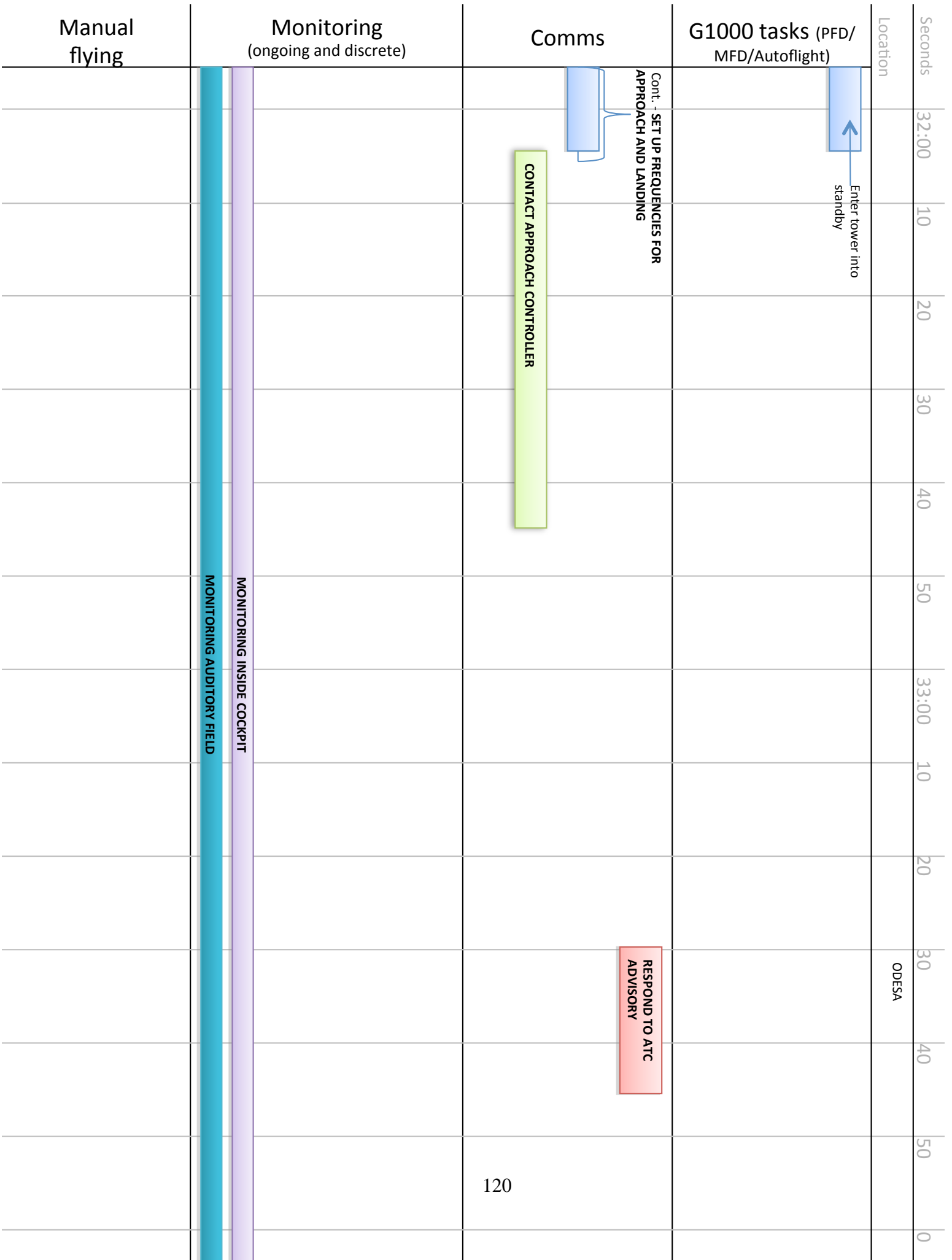

Manual flying	Monitoring (ongoing and discrete)	Comms	G1000 tasks (PFD/MFD/Autoflight)	Location	Seconds
					34:00
					10
					20
					30
					40
					50
					35:00
					10
					20
					30
					40
					50
					0

MONITORING AUDITORY FIELD

MONITORING INSIDE COCKPIT

MONITORING OUTSIDE COCKPIT

ADJUST EXTERNAL LIGHTS



Descending through 10000 MSL

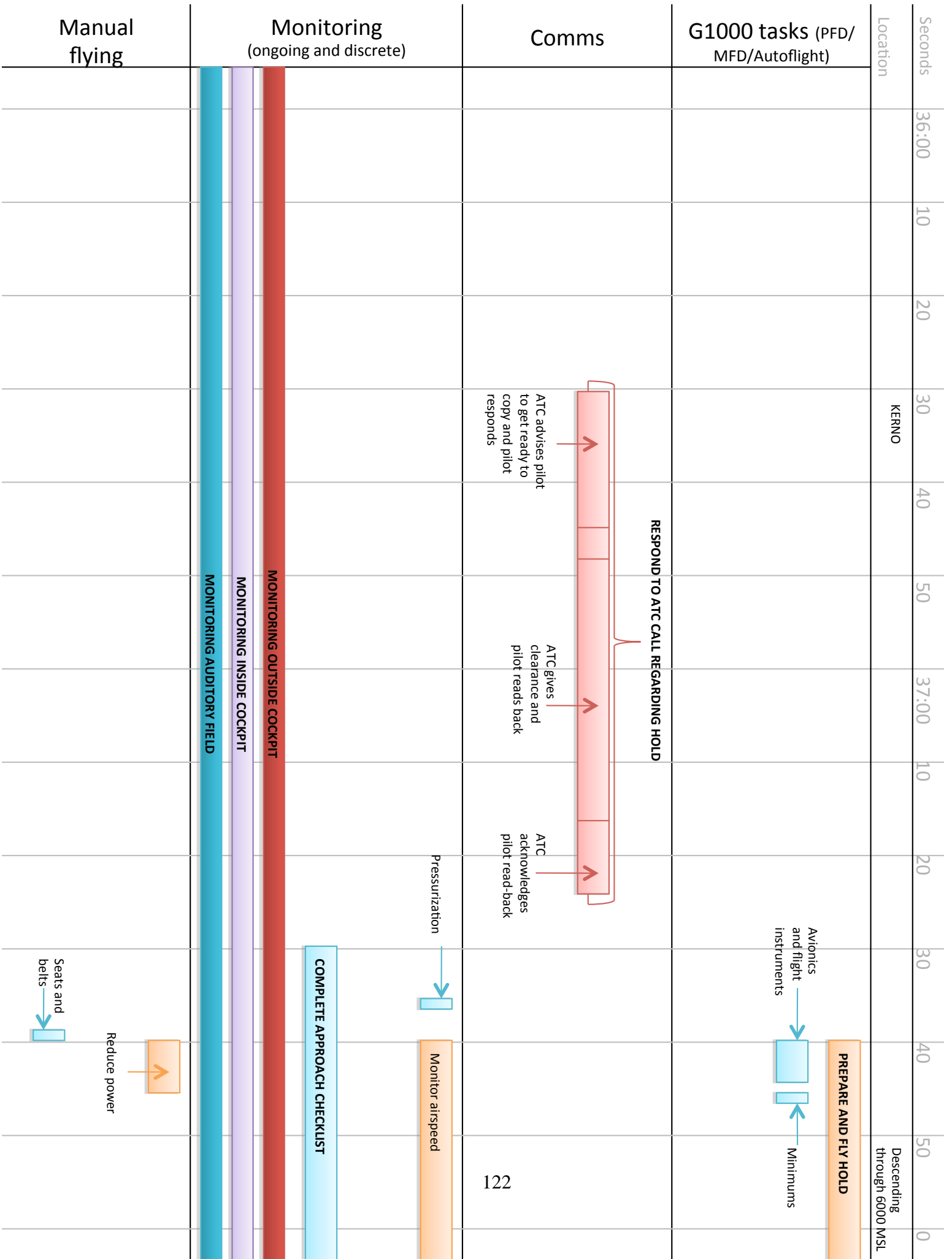

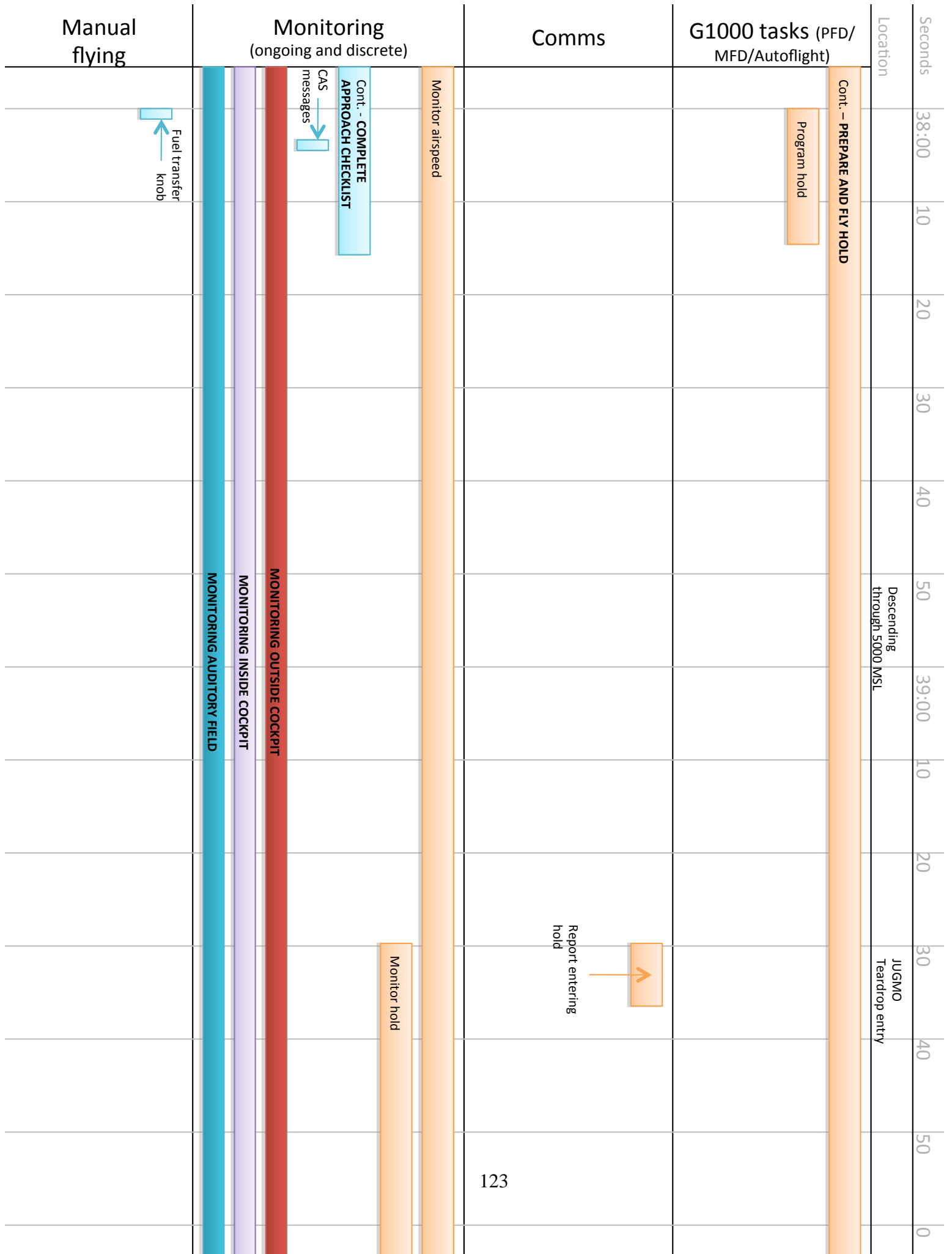

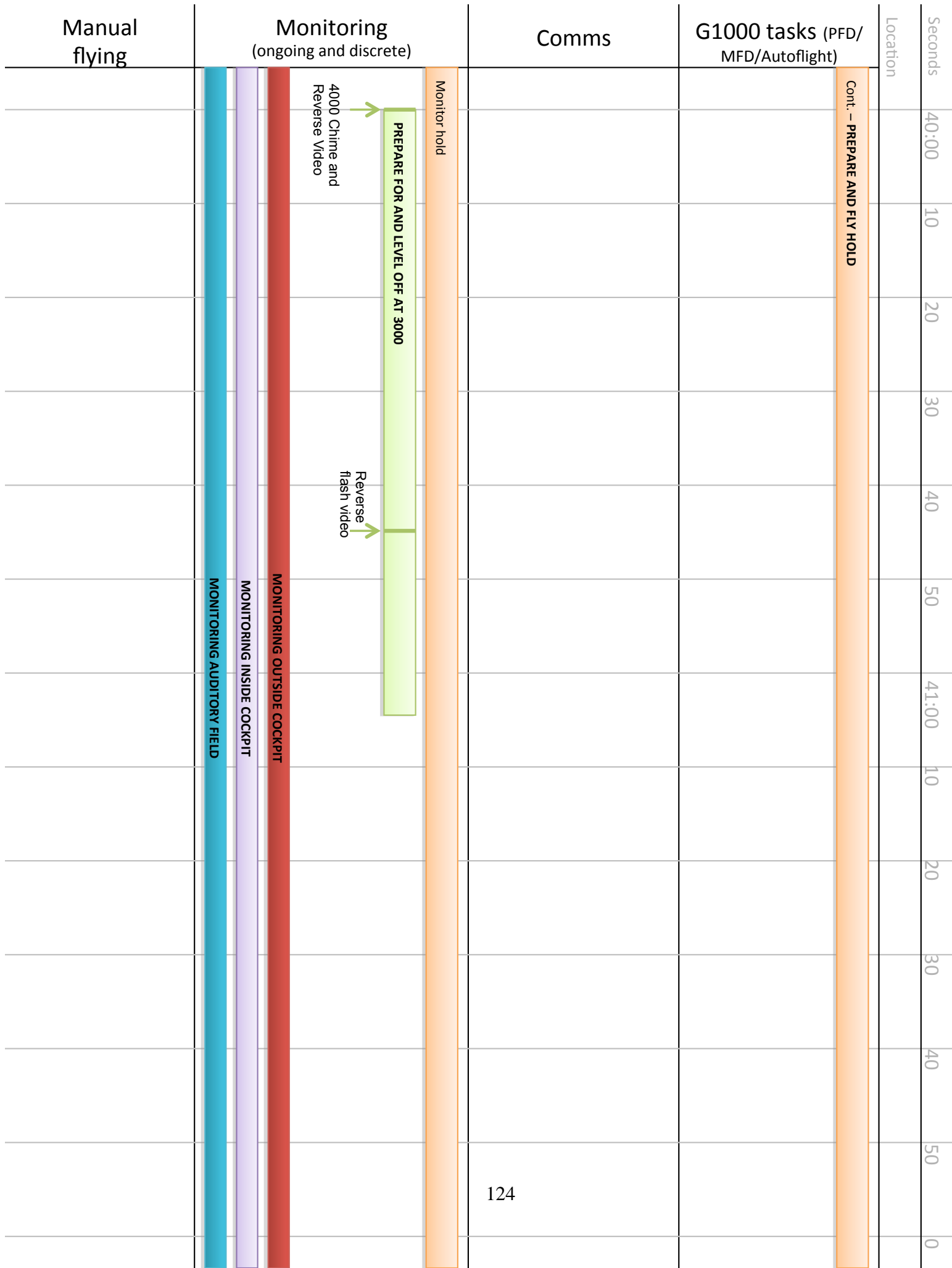

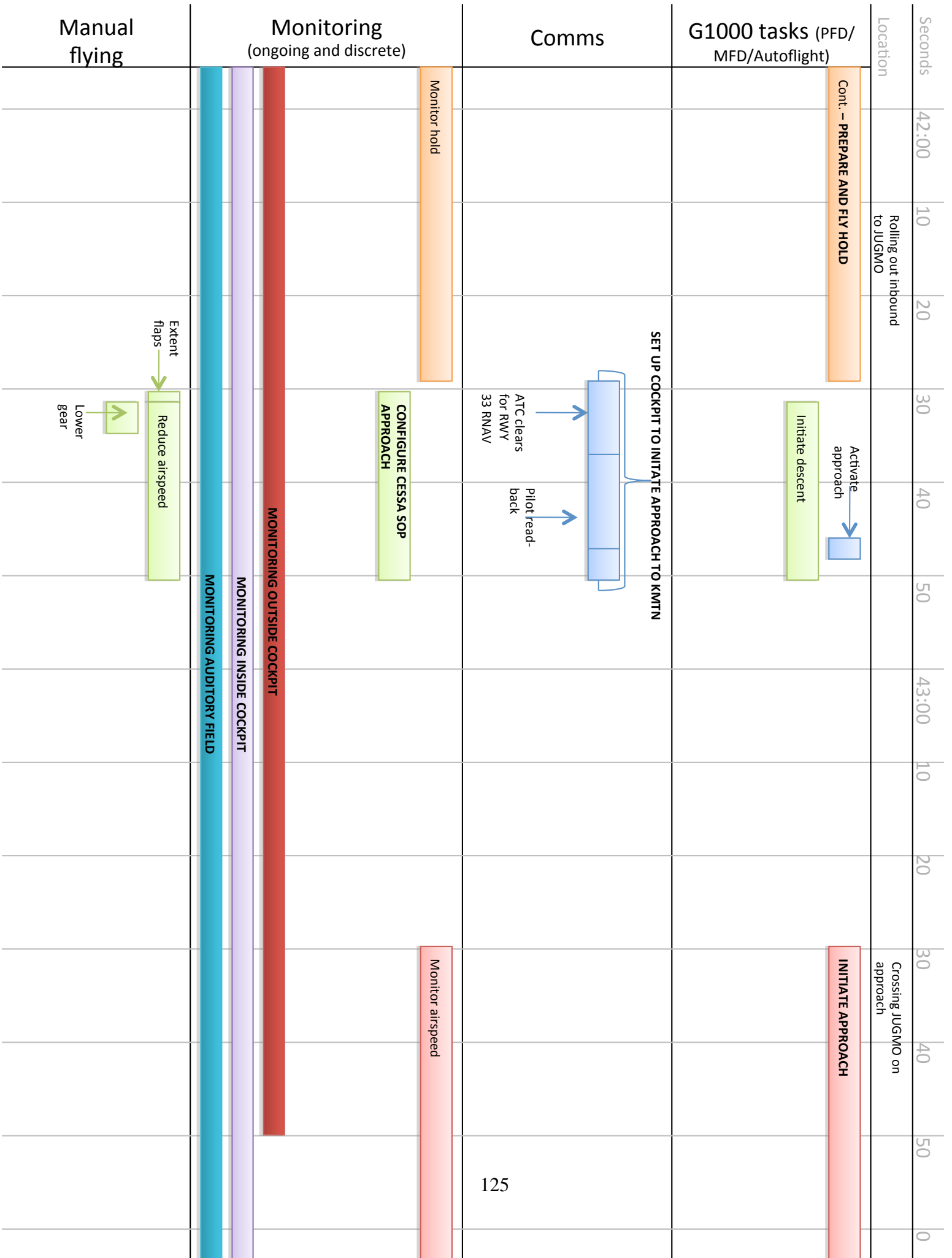

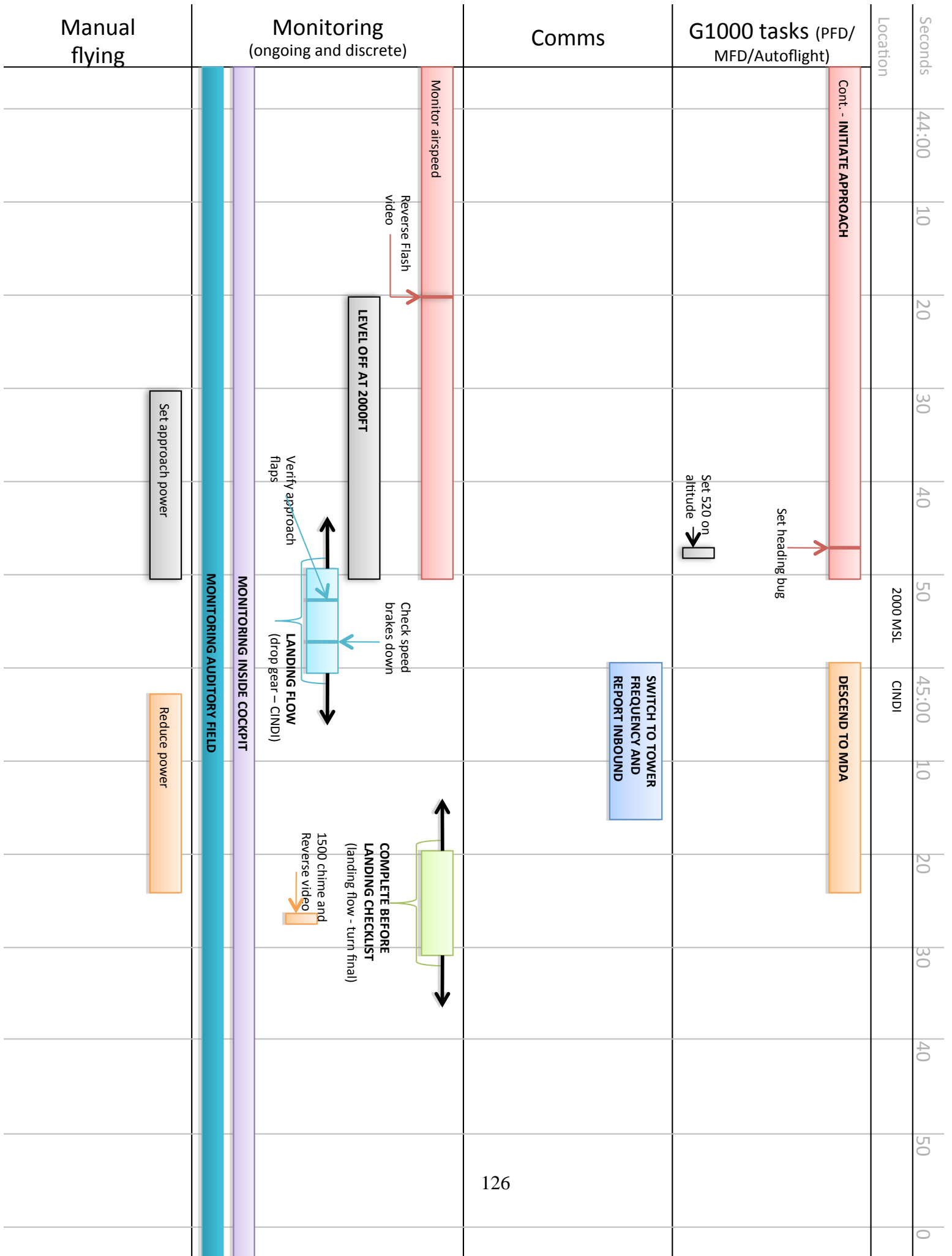

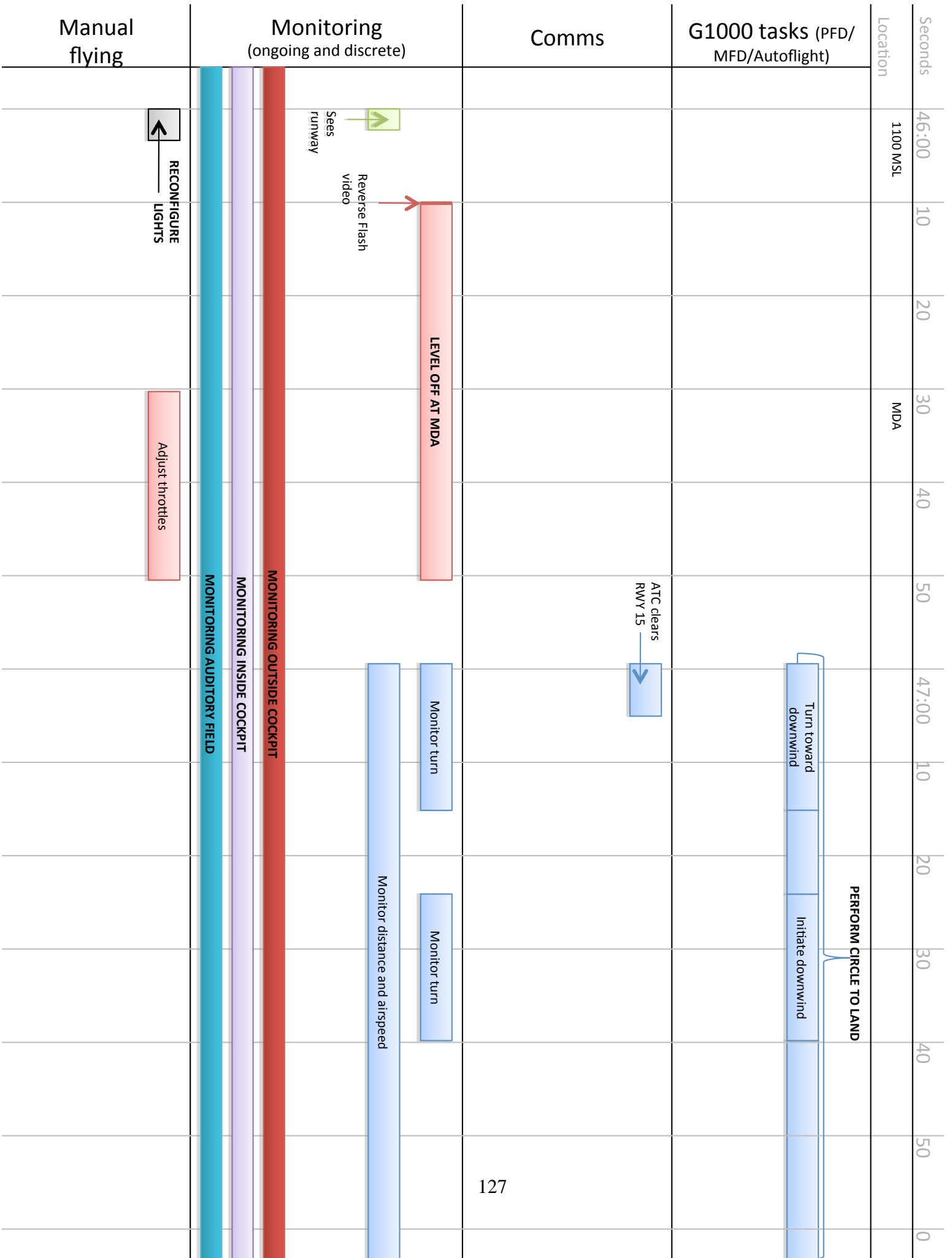

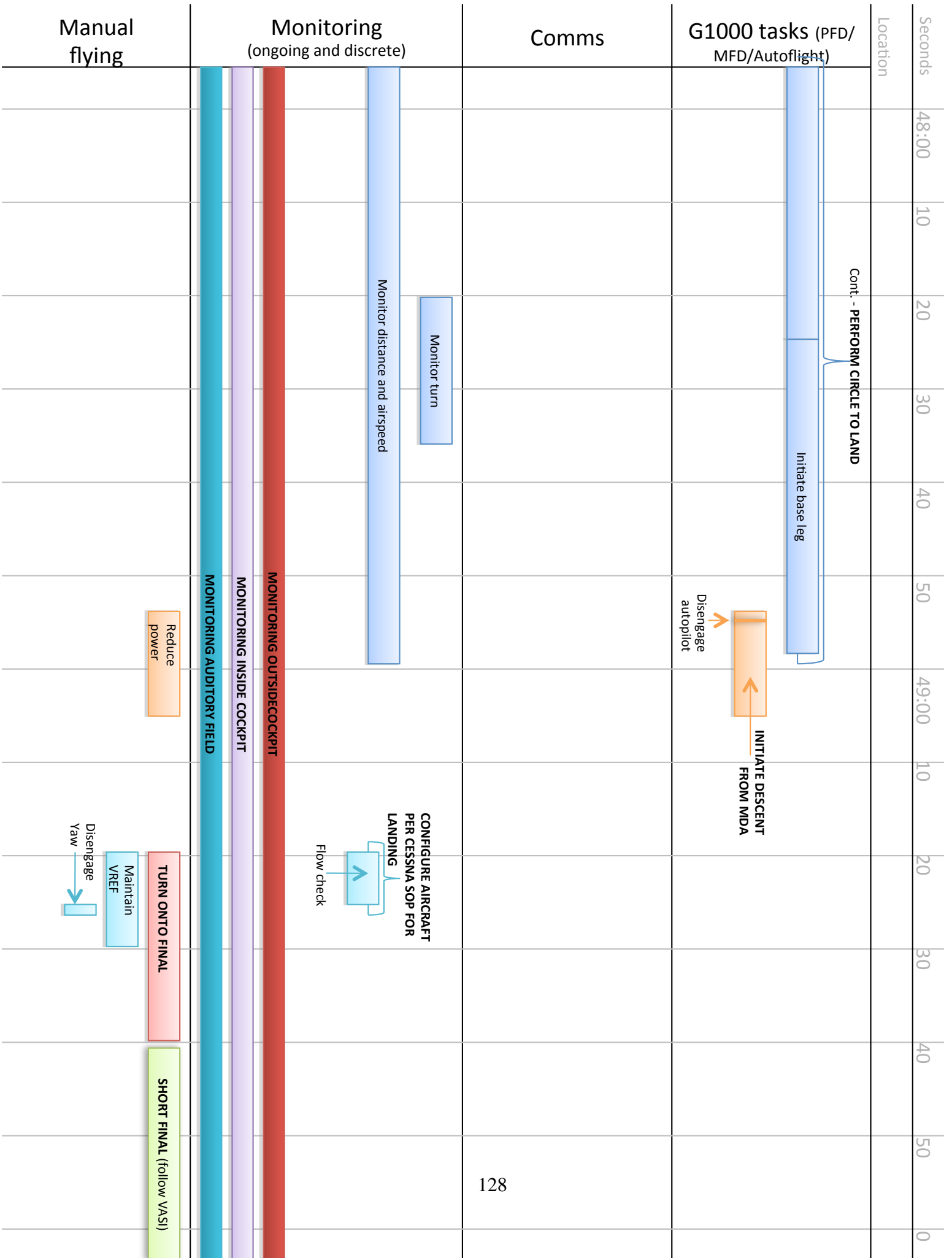



Manual flying	Monitoring (ongoing and discrete)			Comms	G1000 tasks (PFD/MFD/Autoflight)	Location	Seconds
<div data-bbox="282 132 337 422" style="background-color: #d4edda; padding: 2px;">Cont. SHORT FINAL (follow VASI)</div> <div data-bbox="212 359 267 422" style="font-size: small;">Deploy speed brakes</div> <div data-bbox="196 453 267 678">  <p data-bbox="282 527 305 646">LAND PLANE</p> </div> <div data-bbox="131 659 186 949" style="background-color: #ffcdd2; padding: 2px;">EXIT RUNWAY</div>	MONITORING AUDITORY FIELD	MONITORING INSIDE COCKPIT	MONITORING OUTSIDE COCKPIT	129			50:00 10 20 30 40 50 51:00 10 20 30 40 50 0

Appendix B-2. Timeline for Flight Leg 2

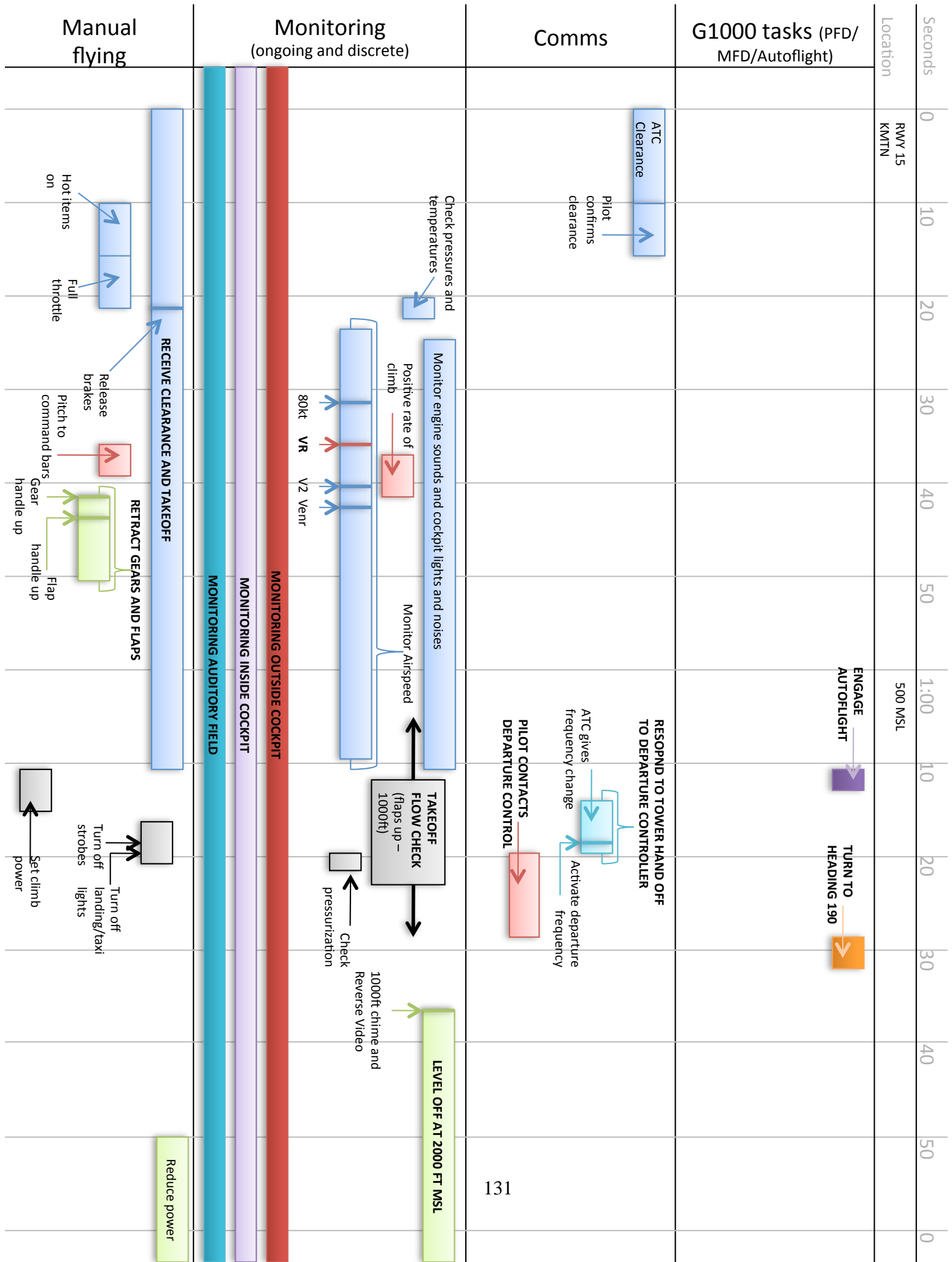

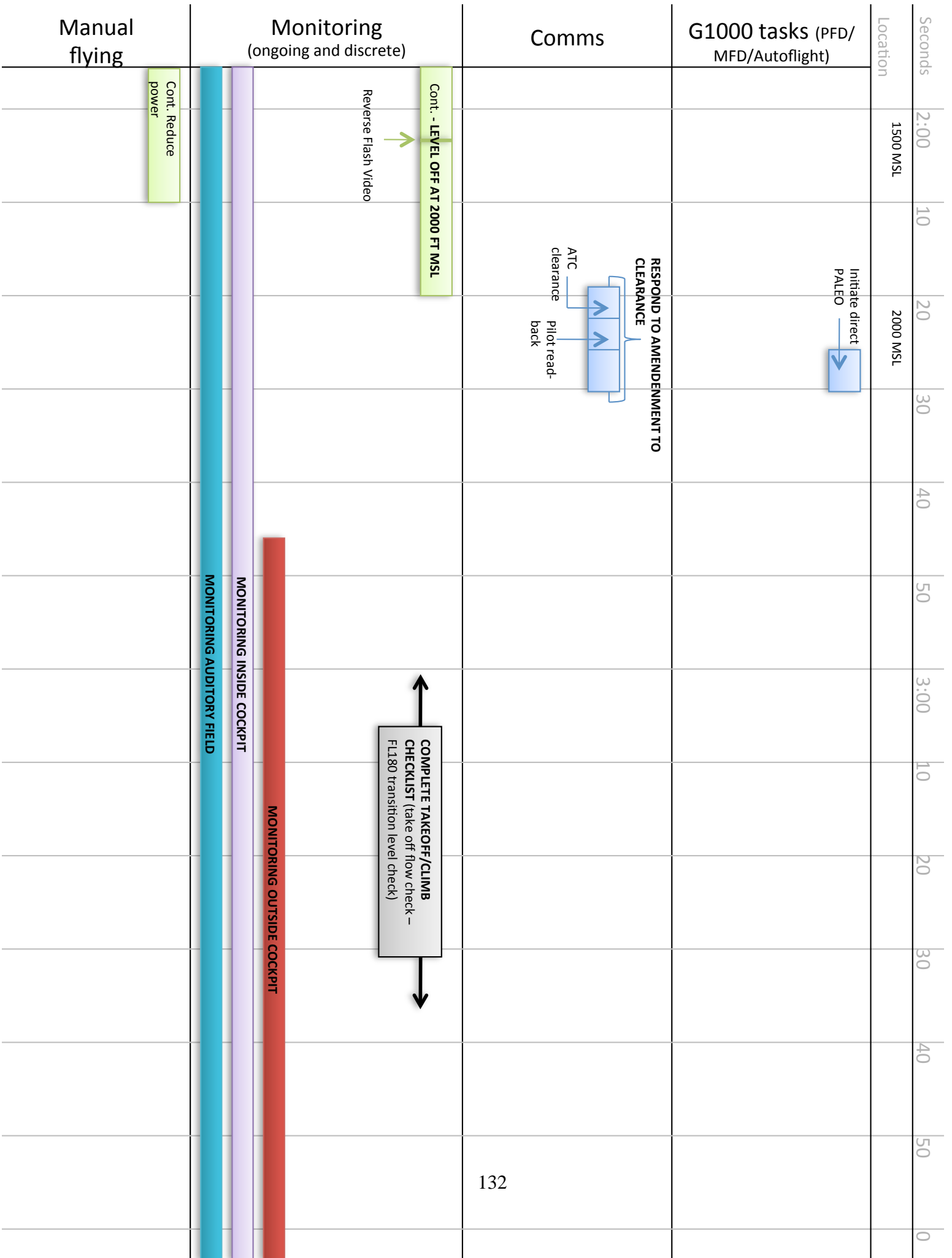

Manual flying	Monitoring (ongoing and discrete)			Comms	G1000 tasks (PFD/MFD/Autoflight)	Location	Seconds
							4:00
							10
							20
							30
							40
							50
							5:00
							10
							20
							30
							40
							50
							0

MONITORING AUDITORY FIELD

MONITORING INSIDE COCKPIT

MONITORING OUTSIDE COCKPIT

Manual flying	Monitoring (ongoing and discrete)			Comms	G1000 tasks (PFD/MFD/Autoflight)	Location	Seconds
							6:00
							10
							20
						Initiate direct OTT	2mm before PALEO
							30
							40
							50
							7:00
							10
							20
							30
							40
							50
							0

MONITORING AUDITORY FIELD

MONITORING INSIDE COCKPIT

MONITORING OUTSIDE COCKPIT

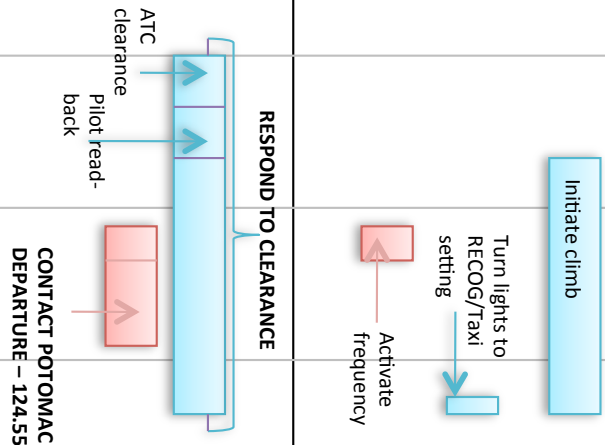
Manual flying	Monitoring (ongoing and discrete)	Comms	G1000 tasks (PFD/MFD/Autoflight)	Location	Seconds
				21nm DME OTT	8:00
					10
					20
					30
					40
					50
					9:00
					10
					20
					30
					40
					50
					0

MONITORING OUTSIDE COCKPIT
MONITORING INSIDE COCKPIT
MONITORING AUDITORY FIELD

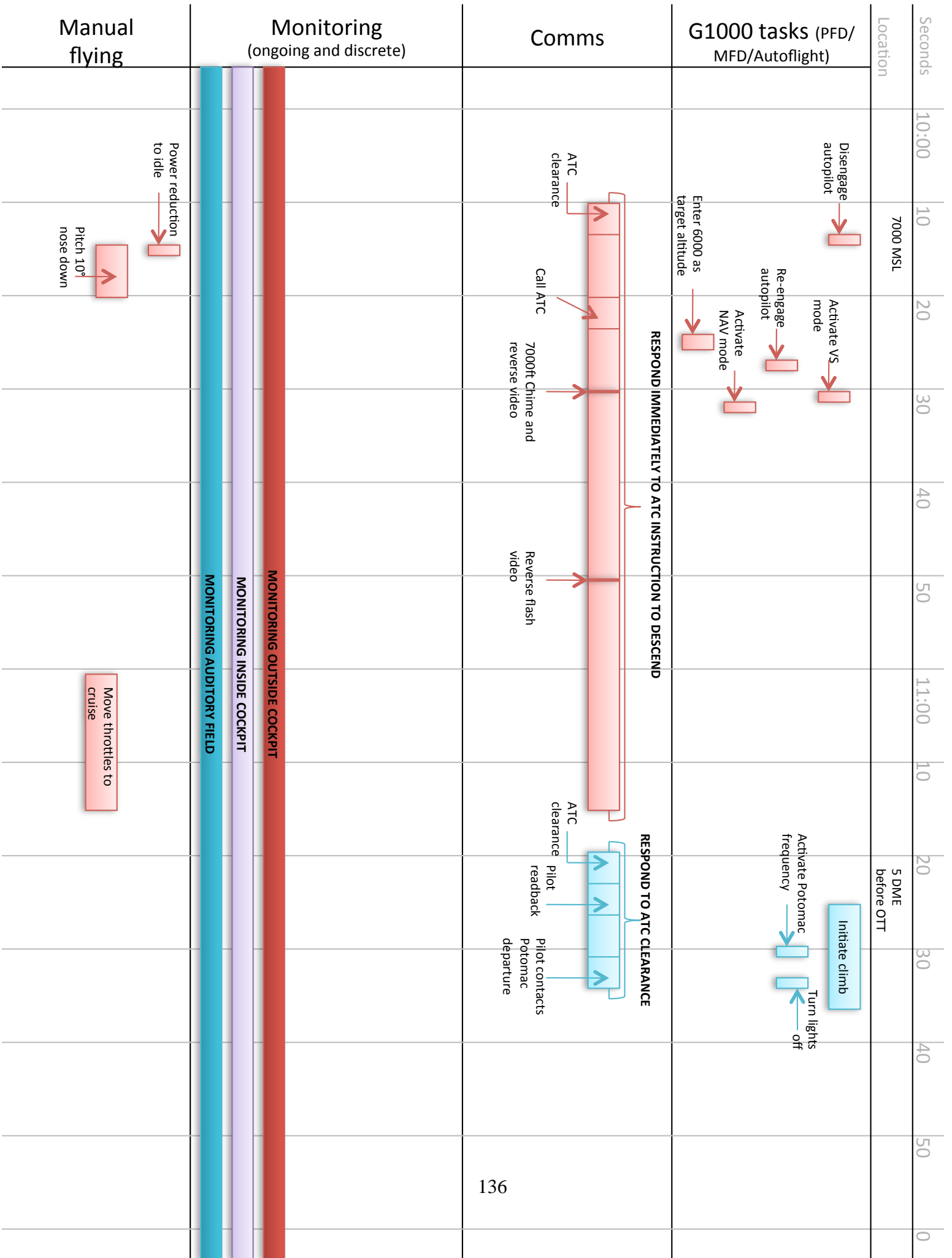

Manual flying	Monitoring (ongoing and discrete)	Comms	G1000 tasks (PFD/MFD/Autoflight)	Location	Seconds
					12:00
					10
					20
					30
					40
					50
					13:00
					10
					20
					30
					40
					50
					0

MONITORING AUDITORY FIELD

MONITORING INSIDE COCKPIT

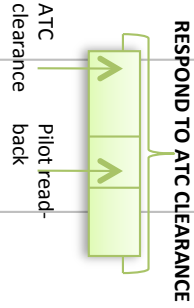

OTT

Manual flying	Monitoring (ongoing and discrete)	Comms	G1000 tasks (PFD/MFD/Autoflight)	Location	Seconds
					14:00
					10
					20
					30
					40
					50
					15:00
					10
					20
					30
					40
					50
					17:00
					0

MONITORING AUDITORY FIELD

MONITORING INSIDE COCKPIT

Turn on engine and wing anti-ice



138

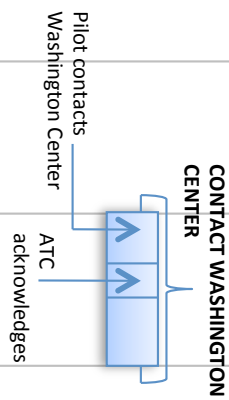

RAT

17000

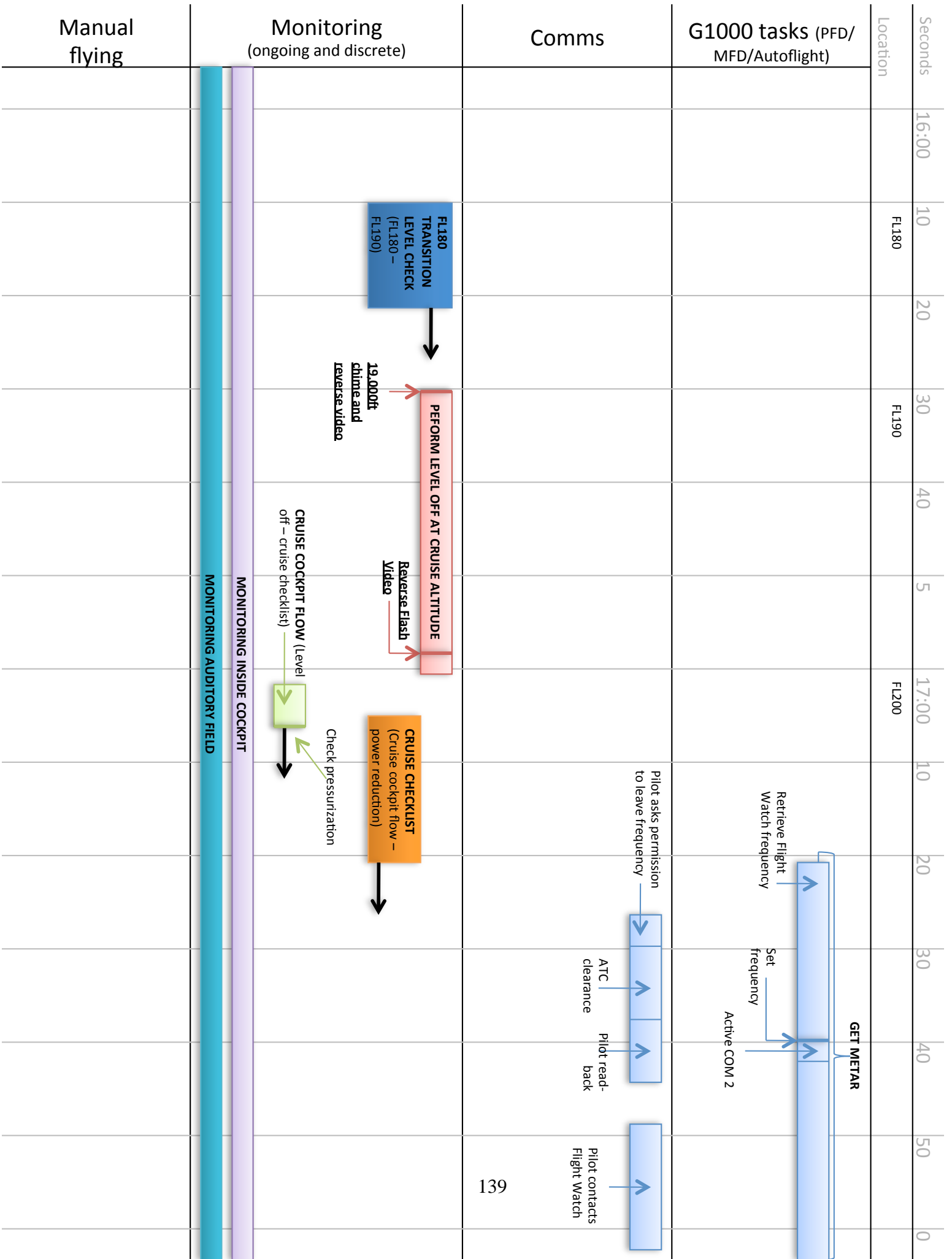

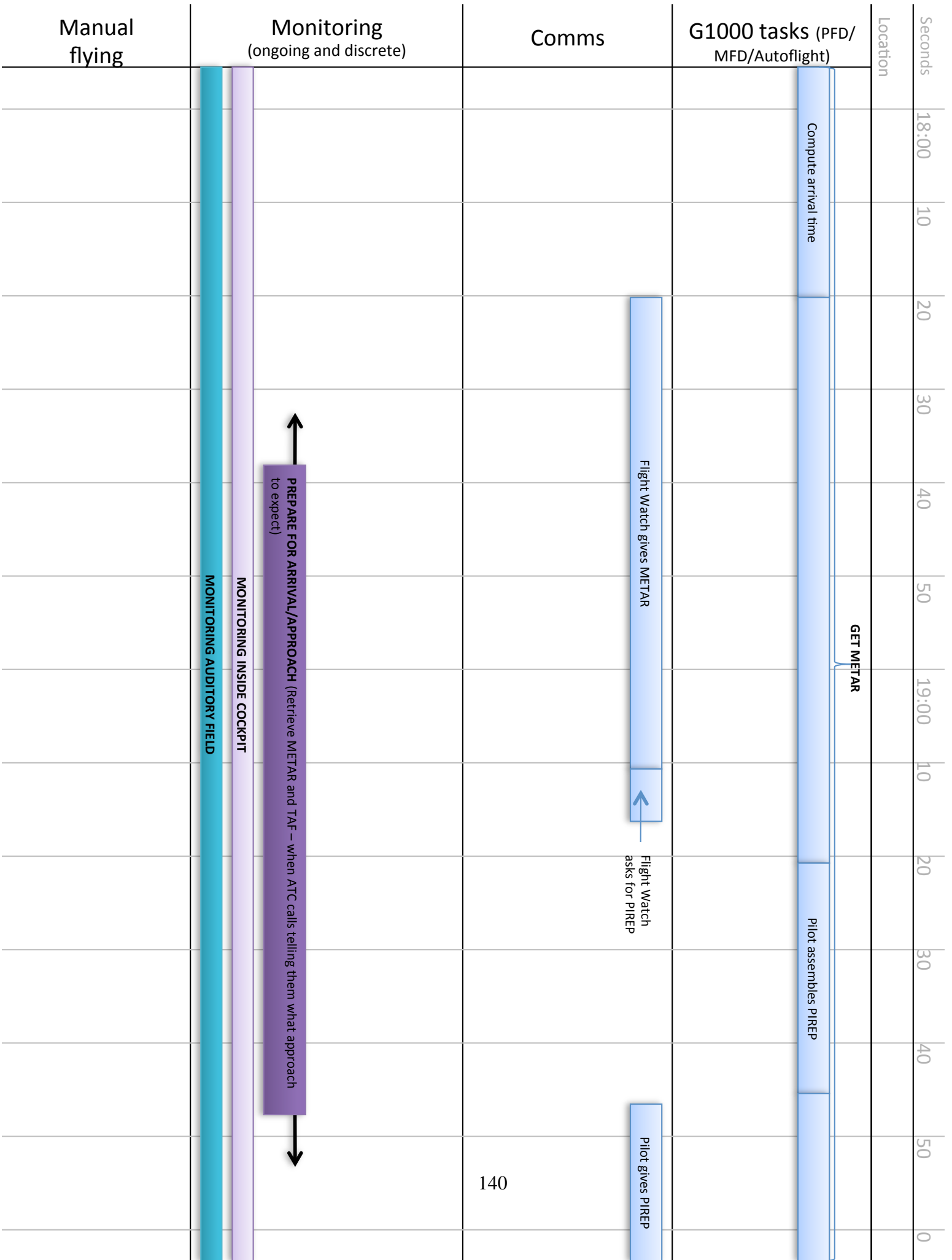

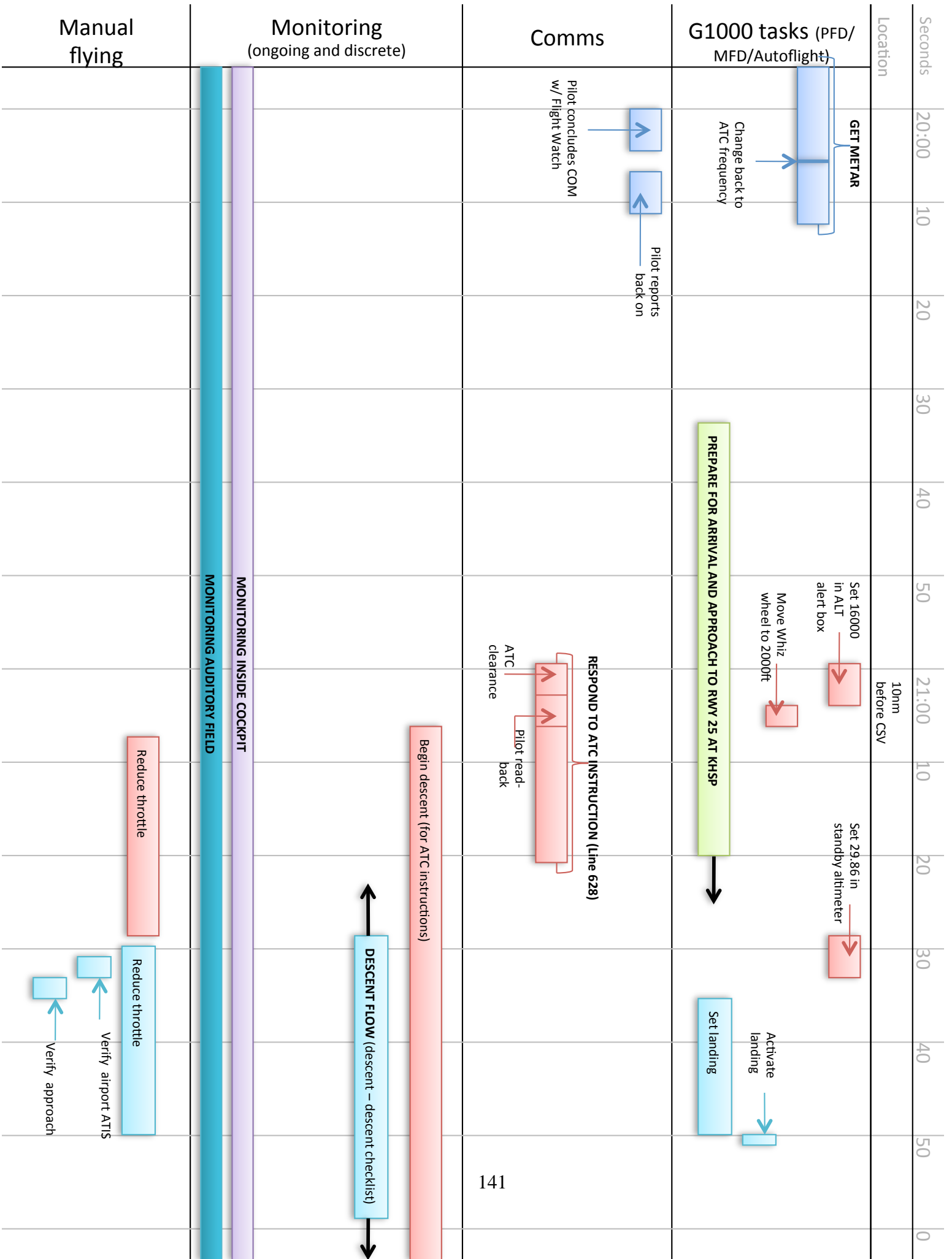

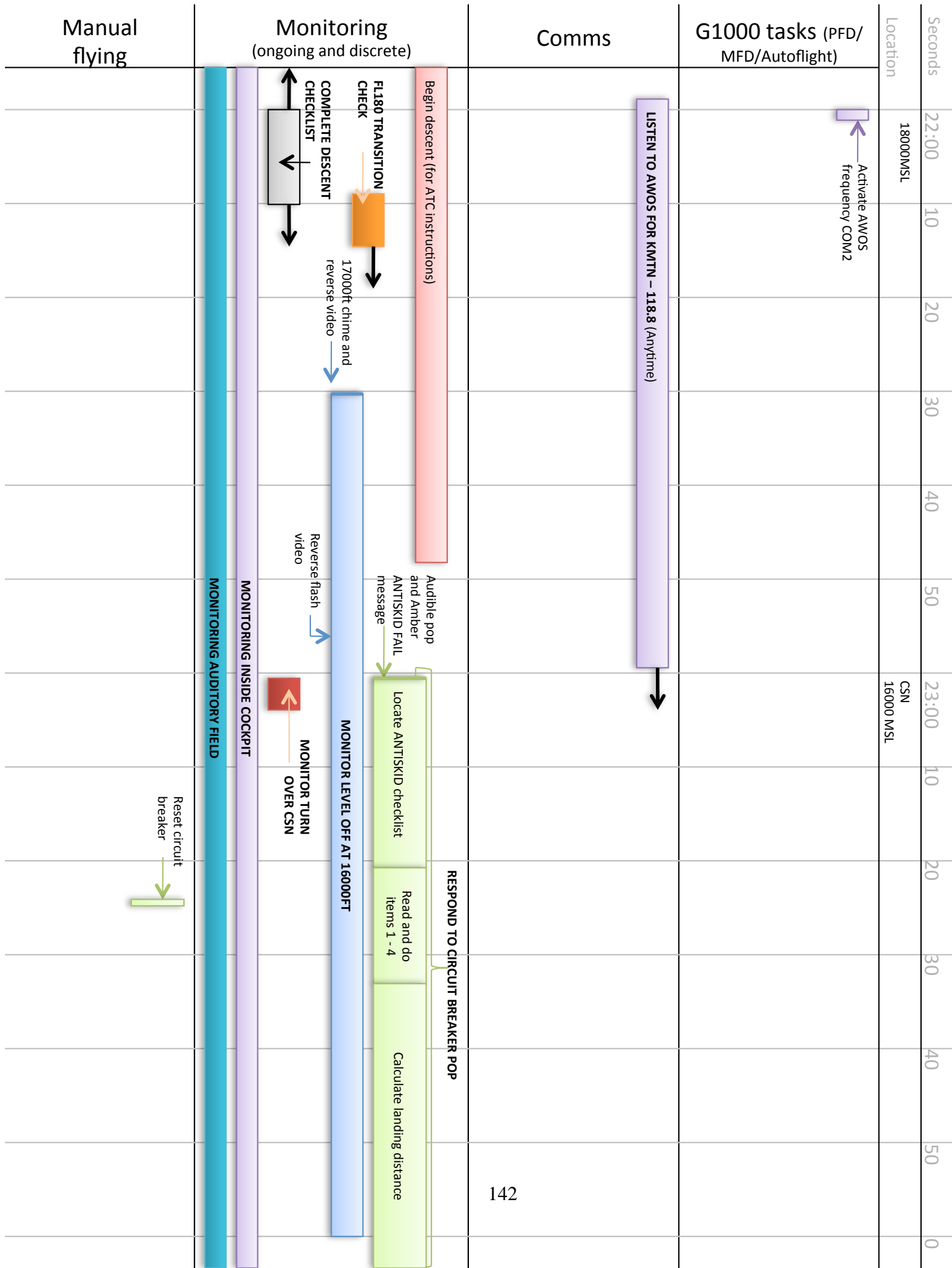

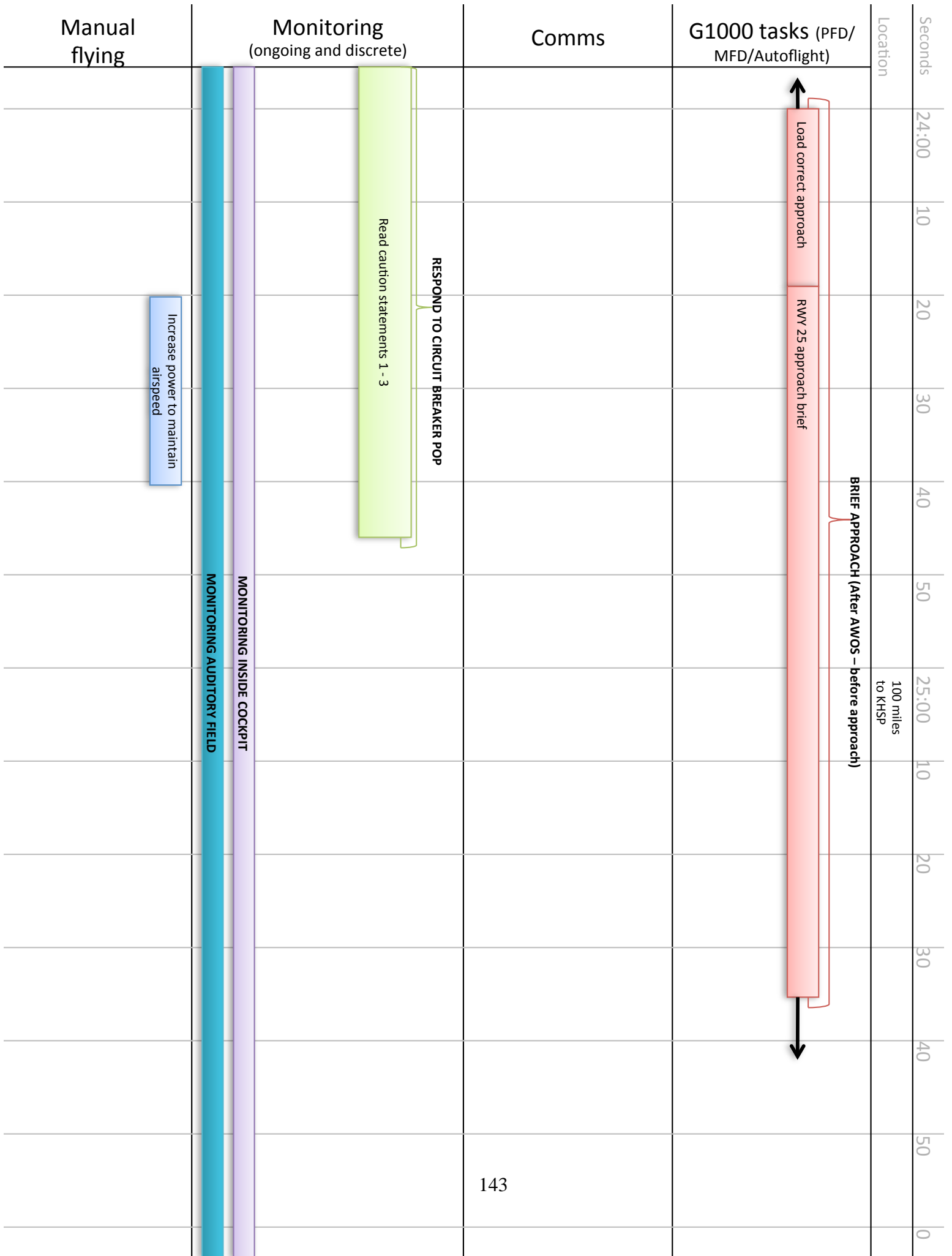

Manual flying	Monitoring (ongoing and discrete)	Comms	G1000 tasks (PFD/MFD/Autoflight)	Location	Seconds
					26:00
					10
					20
					30
					40
					50
					27:00
					10
					20
					30
					40
					50
					0

MONITORING AUDITORY FIELD

MONITORING INSIDE COCKPIT

Manual flying	Monitoring (ongoing and discrete)	Comms	G1000 tasks (PFD/MFD/Autoflight)	Location	Seconds
					28:00
					10
					20
					30
				WITTO	40
					50
					29:00
					10
					20
					30
					40
					50
					0

MONITORING INSIDE COCKPIT
MONITORING AUDITORY FIELD

VNAV warning
MONITOR VNAV INTERCEPT

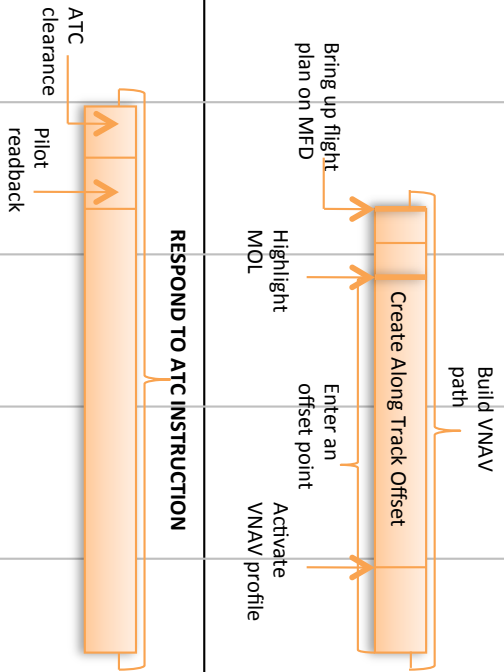

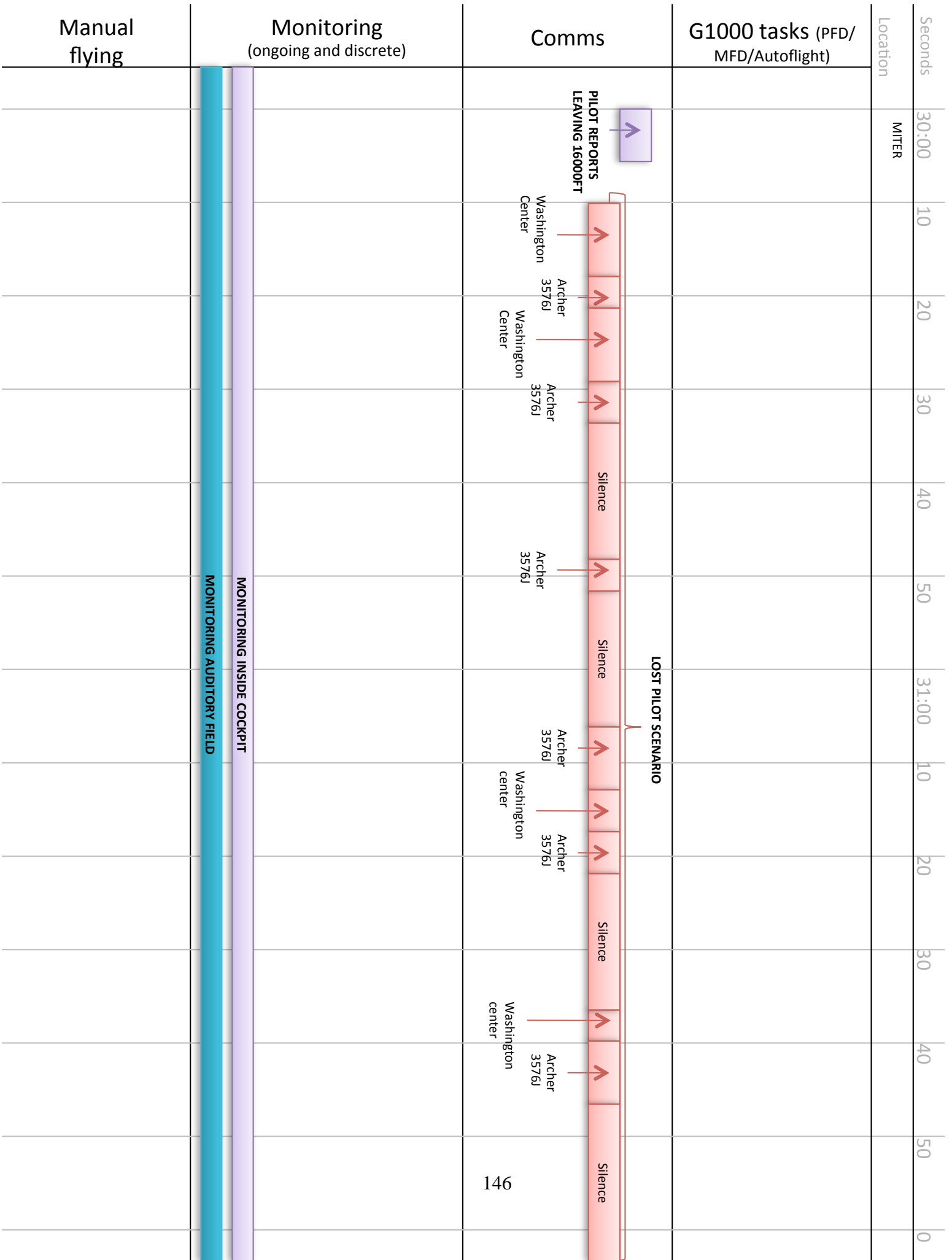

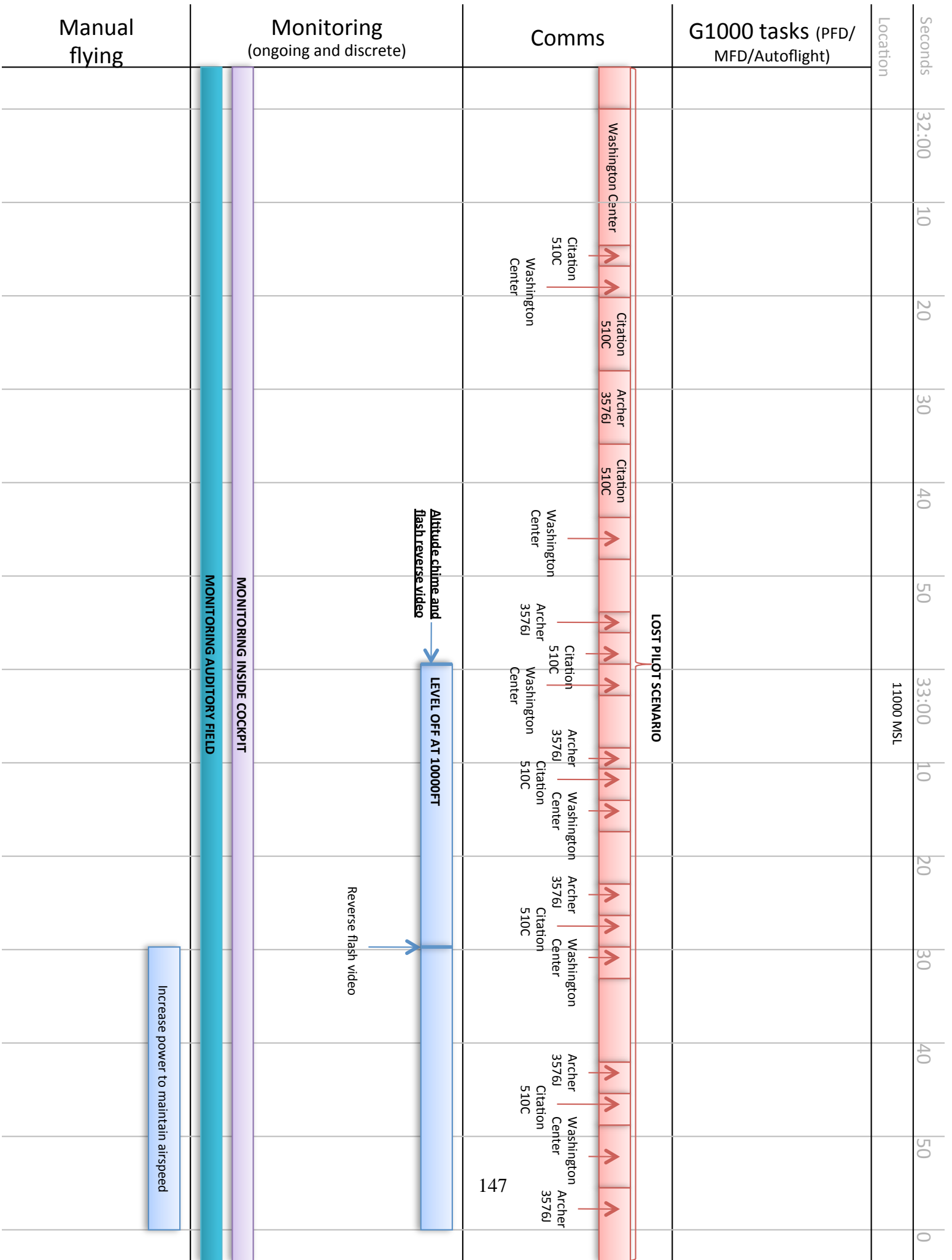

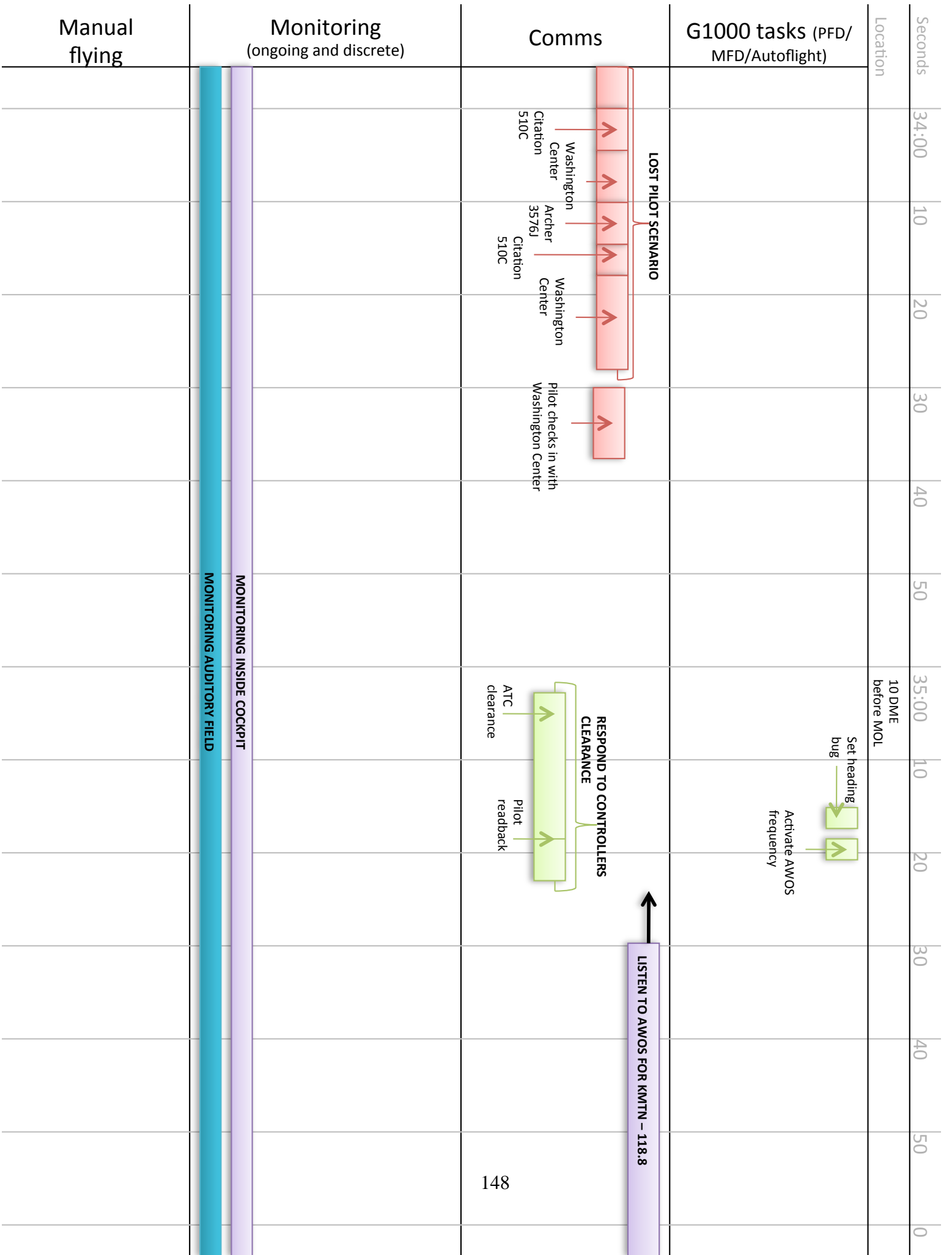

MONITORING AUDITORY FIELD

MONITORING INSIDE COCKPIT

LISTEN TO AWOS FOR KMTN - 118.8

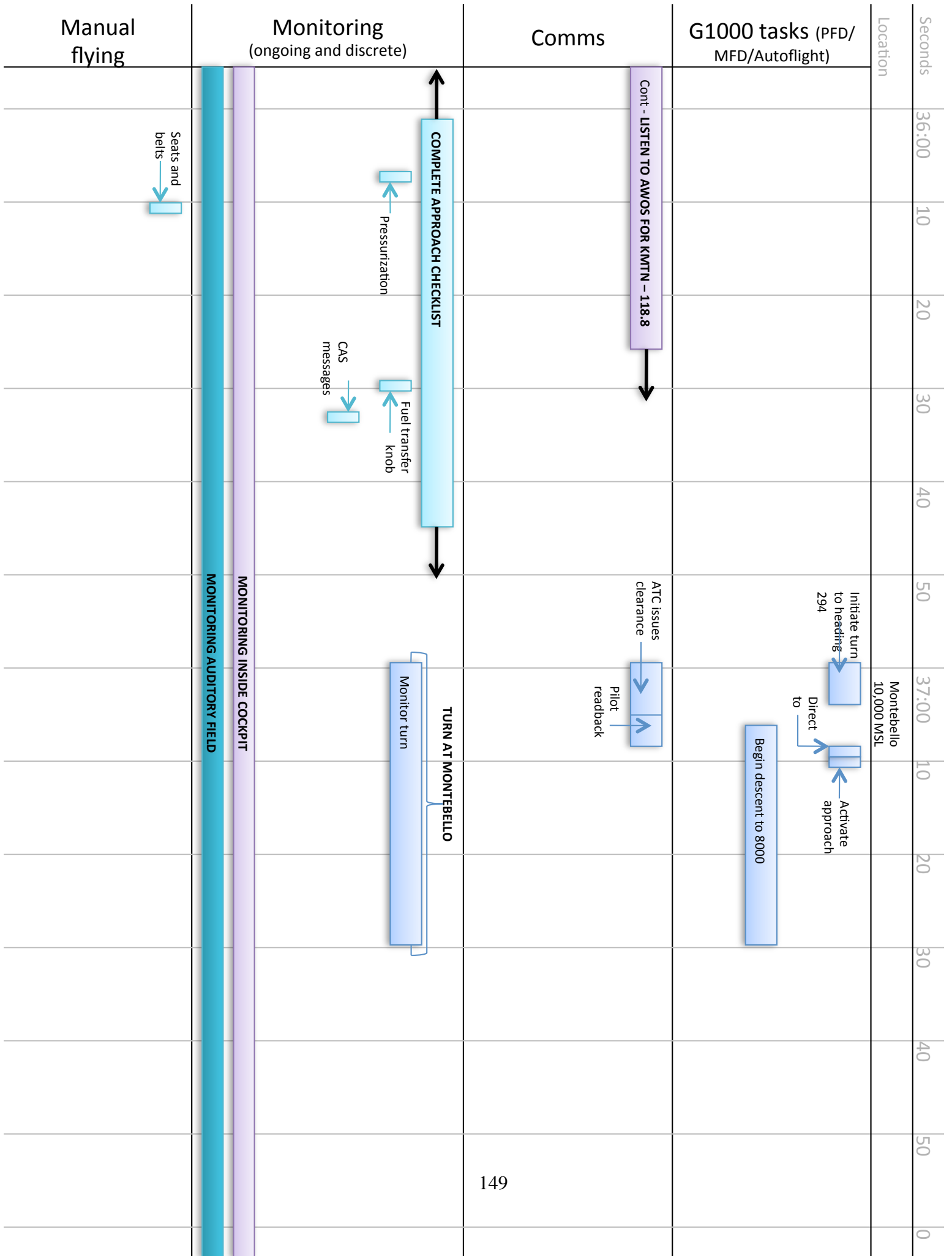

Manual flying	Monitoring (ongoing and discrete)	Comms	G1000 tasks (PFD/MFD/Autoflight)	Location	Seconds
	<p data-bbox="370 953 396 1247">MONITORING AUDITORY FIELD</p> <p data-bbox="423 953 449 1247">MONITORING INSIDE COCKPIT</p> <p data-bbox="561 153 639 342">9000. Altitude chime and flash reverse video</p> <p data-bbox="607 646 630 827">Reverse flash video</p> <p data-bbox="737 218 763 422">LEVEL OFF AT 8000FT</p>	<p data-bbox="821 1927 873 1961">150</p>		<p data-bbox="1484 1125 1510 1222">8000 MSL</p>	<p data-bbox="1533 205 1559 281">38:00</p> <p data-bbox="1533 359 1559 392">10</p> <p data-bbox="1533 512 1559 546">20</p> <p data-bbox="1533 665 1559 699">30</p> <p data-bbox="1533 819 1559 852">40</p> <p data-bbox="1533 972 1559 1005">50</p> <p data-bbox="1533 1125 1559 1201">39:00</p> <p data-bbox="1533 1260 1559 1293">10</p> <p data-bbox="1533 1413 1559 1446">20</p> <p data-bbox="1533 1566 1559 1600">30</p> <p data-bbox="1533 1719 1559 1753">40</p> <p data-bbox="1533 1873 1559 1906">50</p> <p data-bbox="1533 2026 1559 2060">0</p>

Increase power to maintain airspeed

Manual flying	Monitoring (ongoing and discrete)	Comms	G1000 tasks (PFD/MFD/Autoflight)	Location	Seconds
					40:00
					10
					20
					30
					40
					50
					41:00
					10
					20
					30
					40
					50
					0

MONITORING AUDITORY FIELD

MONITORING INSIDE COCKPIT

Manual flying	Monitoring (ongoing and discrete)	Comms	G1000 tasks (PFD/MFD/Autoflight)	Location	Seconds
					42:00
					10
					20
					30
					40
					50
				IFAVU	43:00
					10
					20
					30
					40
					50
					0

Extend flaps

MONITORING AUDITORY FIELD

MONITORING INSIDE COCKPIT

Monitor crossing IFAVU

INITIATE DESCENT TO 6000

START TO CONFIGURE AIRCRAFT PER CESSNA SOP FOR APPROACH



Manual flying	Monitoring (ongoing and discrete)	Comms	G1000 tasks (PFD/MFD/Autoflight)	Location	Seconds
					44:00
					10
					20
					30
					40
					50
				6000 MSL	45:00
					10
					20
					30
					40
					50
					0

MONITORING AUDITORY FIELD

MONITORING INSIDE COCKPIT

LEVEL OFF AT 6000FT

7000 Altitude chime and flash reverse video

Reverse flash video

Manual flying	Monitoring (ongoing and discrete)	Comms	G1000 tasks (PFD/MFD/Autoflight)	Location	Seconds
				AHLER	46:00
					10
					20
					30
					40
					50
					47:00
					10
					20
					30
					40
					50
					0

Reduce airspeed

Turn off wind and engine de-icing

MONITORING AUDITORY FIELD

MONITORING INSIDE COCKPIT

INTERCEPT GLIDESLOPE

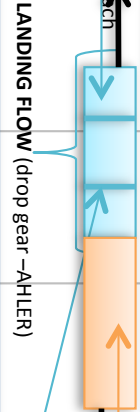

MONITOR TURN AT AHLER

Aircraft turns to 247

Verify approach flaps

LANDING FLOW (drop gear - AHLER)

COMPLETE BEFORE LANDING CHECKLIST (landing flow - turn final)

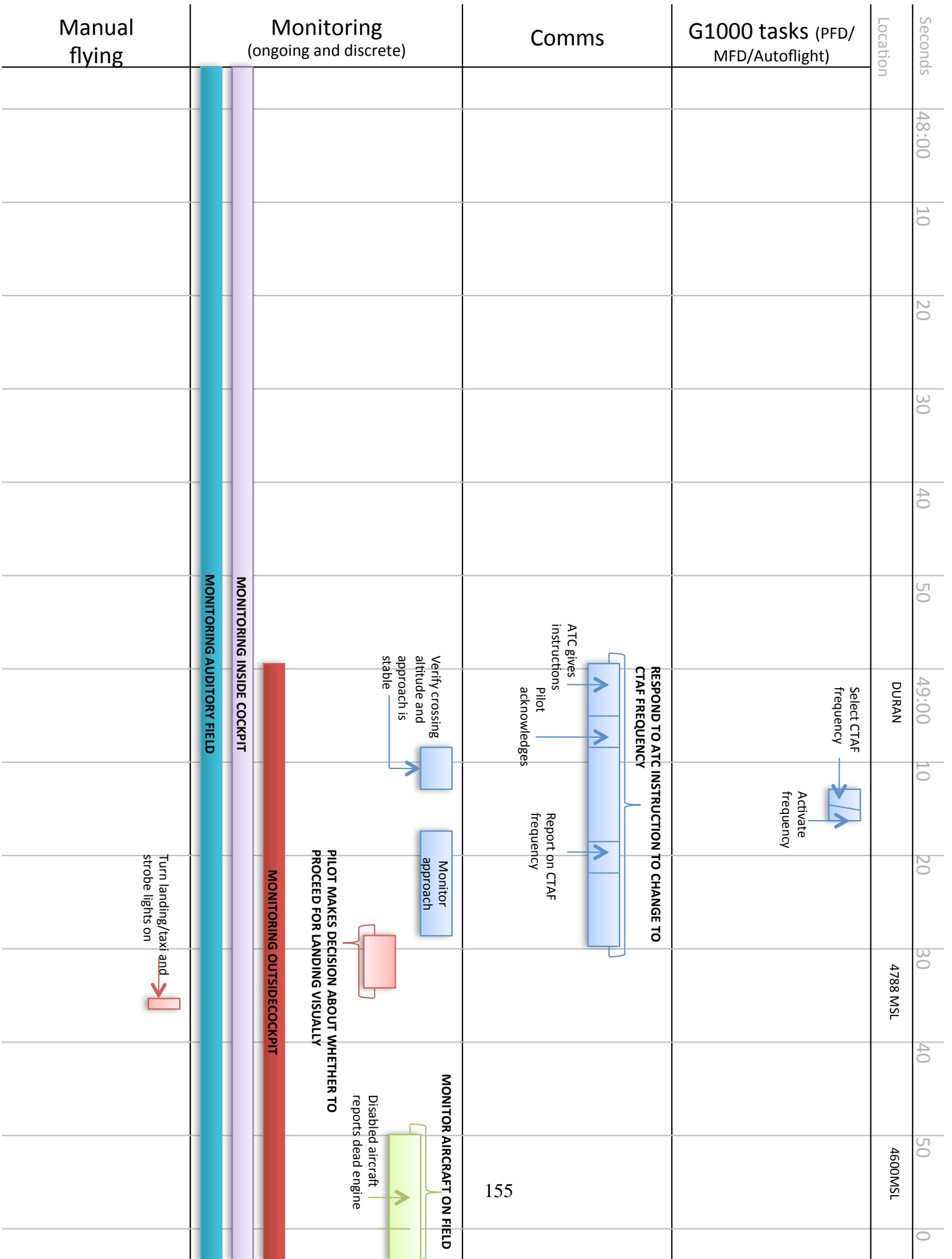

Check speed brakes down

Enter Vap and Vref

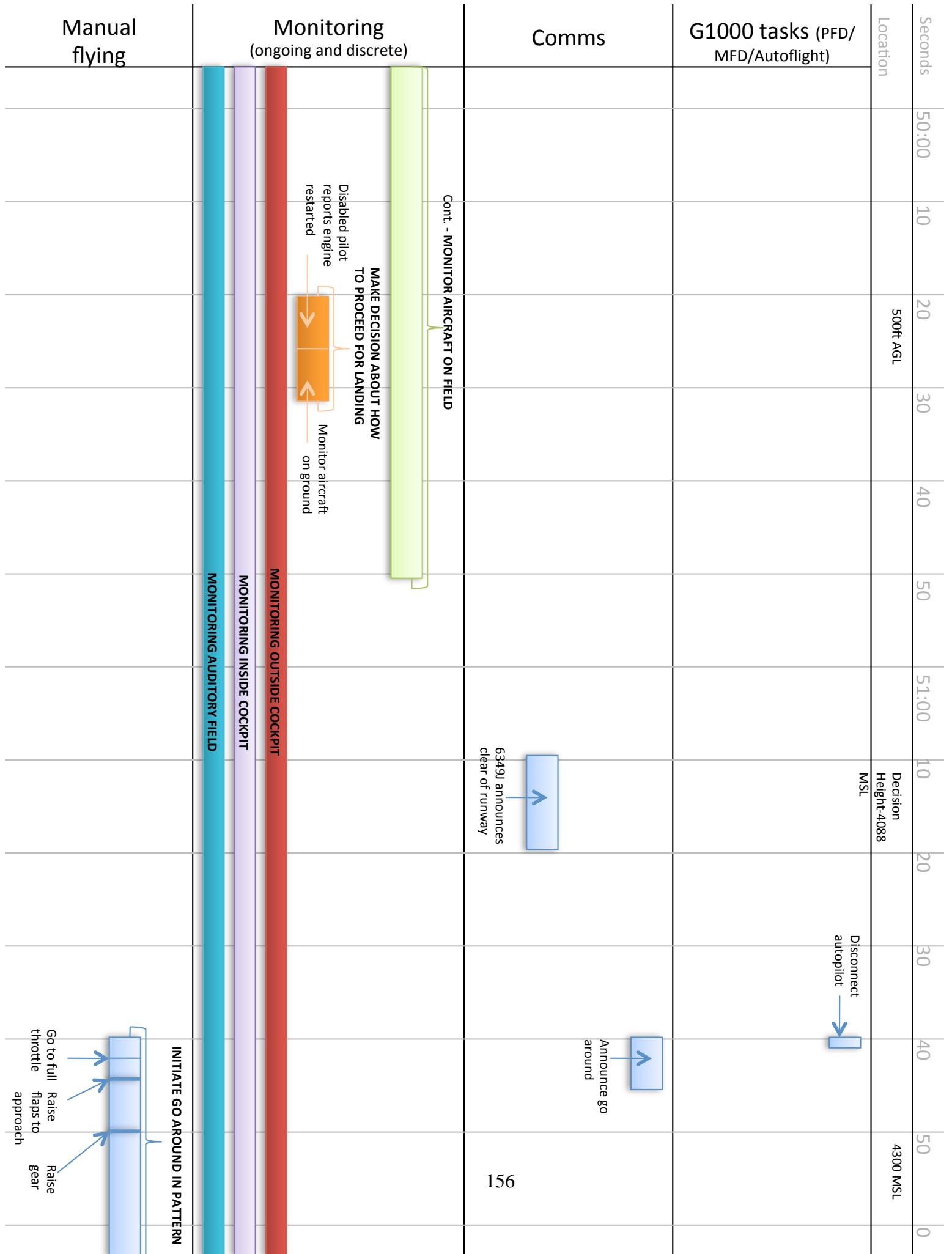

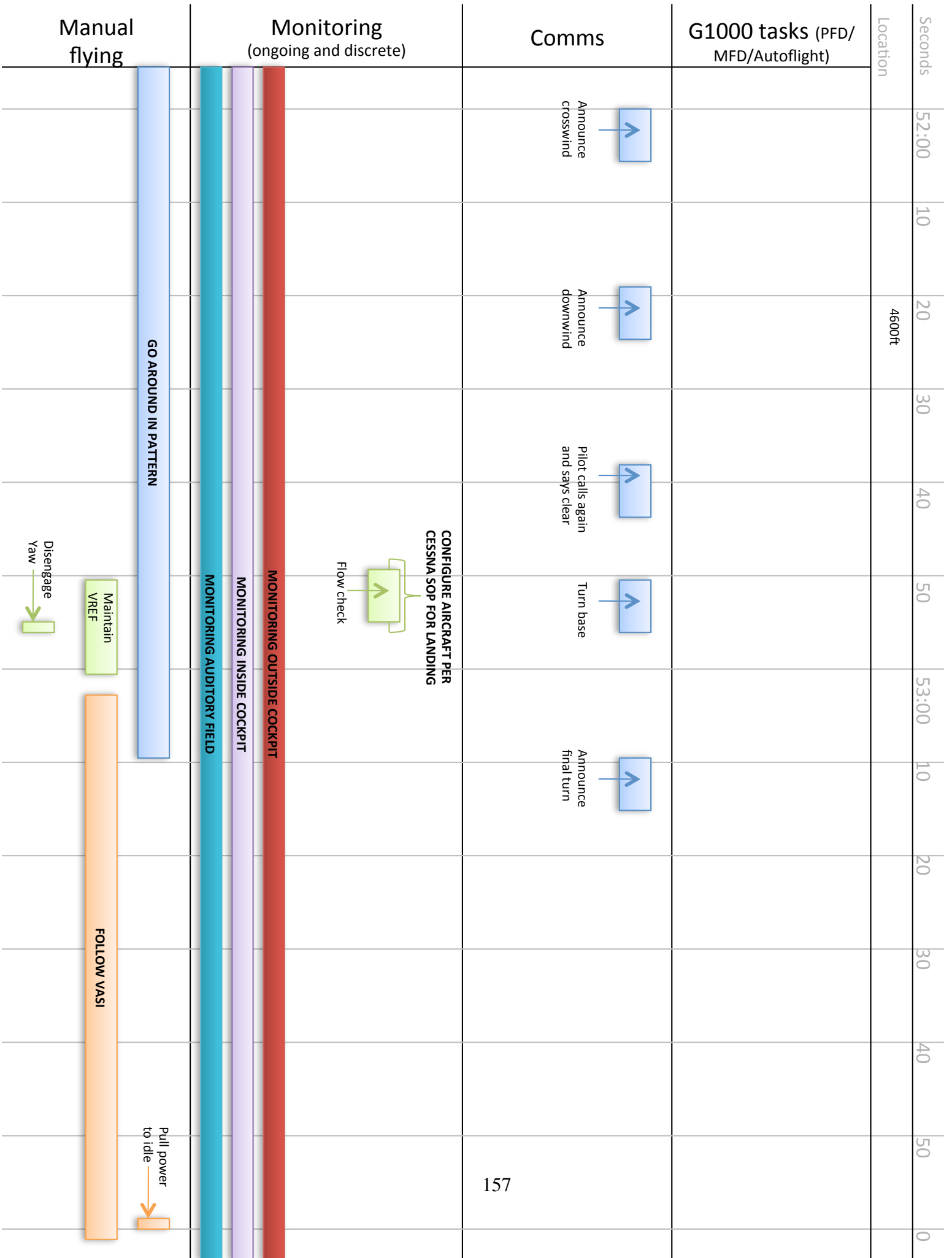



Manual flying	Monitoring (ongoing and discrete)			Comms	G1000 tasks (PFD/MFD/Autoflight)	Location	Seconds
							54:00
Deploy speed brakes 							10
							20
							30
							40
							50
							55:00
							10
							20
							30
							40
							50
				158			0

MONITORING AUDITORY FIELD

MONITORING INSIDE COCKPIT

MONITORING OUTSIDE COCKPIT

LAND PLANE

EXIT RUNWAY